



BTL-5000

Series

USER'S MANUAL

Before You Start

Take a moment to reflect on the advantages of the BTL-5000 Electrical Stimulation, Ultrasound and Laser technology in your own clinic. The BTL-5000 system has many benefits not available on other systems. For example, the touch screen is a major step forward since it allows users to precisely monitor therapy and document and store patient data for later recall. A choice of therapy protocols offers maximum flexibility for a variety of clinical applications.

The combination electrical stimulation / ultrasound / laser therapy system also offers substantial benefits since it eliminates the need to purchase separate units. We sincerely believe the newest BTL physiotherapy system is technically superior to any other physiotherapy products available and will provide years of trouble-free and profitable use.

All of us at BTL wish you every success with your BTL-5000 system. We pride ourselves on being as responsive as possible to our customer's needs. Your suggestions and comments are always welcome since we believe an ongoing relationship with our customers is critically important to our future product line. Please call us or email us your suggestions.

While we would like you to start using your equipment right away, we encourage a thorough reading of this manual in order to fully understand the operational features of the BTL-5000 system.

Please remember to complete the warranty registration form printed in this manual. The warranty form should be returned to us no later than 30 days following installation of your equipment to initiate warranty protection.

Again, thanks for being a BTL customer. In the event of a problem, or if you require service, please make an initial call to your local distributor, who will decide whether to refer the problem to our office.

CONTENTS

| | | |
|----------|---|-----------|
| 1 | GENERAL CHARACTERISTICS | 5 |
| 2 | INSTRUCTIONS FOR USE | 6 |
| 2.1 | Front View..... | 6 |
| 2.2 | Rear View..... | 7 |
| 2.3 | Unpacking and Assembly..... | 9 |
| 2.4 | Operating the Unit..... | 10 |
| 2.4.1 | Touch Screen..... | 10 |
| 2.4.2 | Numerical Keyboard..... | 11 |
| 2.5 | Therapy Setting..... | 12 |
| 2.5.1 | Therapy Flow Chart..... | 12 |
| 2.5.2 | Welcome Screen and Selection of Channels, Tabs and Accessories..... | 13 |
| 2.5.3 | Setting Therapy Parameters via the 'diag' Button..... | 14 |
| 2.5.4 | Setting Therapy Parameters via the 'prog' Button..... | 15 |
| 2.5.5 | Setting Therapy Parameters Manually via the 'man' Button..... | 16 |
| 2.5.6 | Therapy Parameters Screen – Ergonomic, Standard and Expert Mode..... | 17 |
| 2.5.6.1 | Setting Therapy Time..... | 17 |
| 2.5.6.2 | Setting Intensity..... | 17 |
| 2.6 | Course of Therapy..... | 18 |
| 2.6.1 | Start, Interruption and End of Therapy..... | 18 |
| 2.6.2 | Running Therapy Screen..... | 19 |
| 2.6.3 | Electrotherapy – Settings during Therapy..... | 19 |
| 2.6.3.1 | Setting the Intensity in 4-electrode Therapies..... | 19 |
| 2.6.3.2 | Manual Control of Vector in Dipole Interference..... | 19 |
| 2.6.4 | Accessories – Visual Signaling..... | 20 |
| 2.6.5 | Indication of Operation – Energy on Output..... | 20 |
| 2.6.5.1 | Electrotherapy..... | 20 |
| 2.6.5.2 | Ultrasound Therapy..... | 21 |
| 2.6.5.3 | Laser Therapy..... | 21 |
| 2.7 | Therapy Parameters..... | 21 |
| 2.8 | Encyclopaedia..... | 22 |
| 2.9 | Therapy Printing and Saving..... | 23 |
| 2.9.1 | Save Therapy..... | 23 |
| 2.9.2 | Save Therapy and Add It to the Patient Data..... | 23 |
| 2.10 | Interconnection of Units..... | 26 |
| 2.10.1 | Interconnection of BTL-5000 Puls (Combi) and Vacuum Unit BTL vac..... | 26 |
| 2.10.2 | Interconnection of BTL-5000 Puls and BTL-5000 Sono..... | 26 |
| 2.10.3 | Interconnection of BTL-5000 Puls, BTL-5000 Sono and BTL vac..... | 27 |
| 2.10.4 | Setup and Operation of Combined Therapy in Single Devices..... | 28 |
| 2.10.5 | Stopping Combined Therapy in Single Devices..... | 28 |
| 3 | MENU BUTTON | 29 |
| 3.1 | Accessories..... | 29 |
| 3.1.1 | Installation of Accessories..... | 29 |
| 3.1.2 | Information about Accessories..... | 29 |
| 3.1.3 | Connectors - Information..... | 29 |
| 3.2 | Unit Settings..... | 30 |
| 3.2.1 | Password Setting..... | 30 |
| 3.2.2 | Audio Tones Setting..... | 30 |
| 3.2.3 | Setting of Colours (for colour variant only)..... | 30 |
| 3.2.4 | LCD Screen Saver and Auto Power Off..... | 30 |
| 3.2.5 | Setting of Contrast of LCD Screen..... | 30 |
| 3.2.6 | Date and Time Setting..... | 30 |
| 3.2.7 | Language Setting..... | 30 |
| 3.2.8 | Operation Mode..... | 31 |
| 3.2.9 | Touch Panel Calibration..... | 31 |
| 3.2.10 | User Options..... | 31 |
| 3.2.11 | Way of Operation..... | 31 |
| 3.2.11.1 | New Operation Mode..... | 31 |
| 3.2.11.2 | End of Therapy – Setting Zero Intensity and Time Values..... | 31 |
| 3.2.12 | Network Setting..... | 31 |
| 3.2.13 | Information about the Unit..... | 31 |
| 3.2.14 | Service Functions..... | 31 |

| | | |
|----------|--|-----------|
| 3.2.14.1 | Repair of Files..... | 31 |
| 3.2.14.2 | File System Formatting..... | 32 |
| 3.2.14.3 | Delete Installed Accessories..... | 32 |
| 3.2.14.4 | Default Setting without Losing User Data..... | 32 |
| 3.2.14.5 | Restart of All Generators..... | 32 |
| 3.2.14.6 | Information of Free Space for User Data..... | 32 |
| 3.2.15 | Special Settings..... | 32 |
| 4 | USER OPTIONS VIA THE “USER” BUTTON..... | 33 |
| 4.1 | Patients..... | 33 |
| 4.2 | User Sequences..... | 34 |
| 4.2.1 | Creating New Sequence..... | 34 |
| 4.2.1.1 | Parameters of Sections in Sequence..... | 36 |
| 4.2.2 | Saving New Sequence..... | 36 |
| 4.3 | User Diagnoses/Programs..... | 37 |
| 4.4 | List of Recent Therapies..... | 37 |
| 5 | ACCESSORIES..... | 38 |
| 5.1 | Accessories Common for All Units..... | 38 |
| 5.2 | Accessories for Electrotherapy..... | 38 |
| 5.3 | Accessories for Ultrasound Therapy..... | 38 |
| 5.4 | Accessories for Laser Therapy..... | 38 |
| 6 | MAINTENANCE AND SAFETY INSTRUCTIONS..... | 39 |
| 6.1 | Safety..... | 40 |
| 6.2 | Useful addresses..... | 42 |
| 6.3 | Warranty..... | 42 |
| 6.4 | Contraindications..... | 43 |
| 6.4.1 | Contraindications - Electrotherapy..... | 43 |
| 6.4.2 | Contraindications - Ultrasound..... | 43 |
| 6.4.3 | Contraindications – Laser therapy..... | 43 |
| 7 | TECHNICAL PARAMETERS..... | 44 |
| 7.1 | Basic Parameters of Electrotherapy Generator..... | 44 |
| 7.2 | Basic Parameters of Ultrasound Generator..... | 45 |
| 7.3 | Basic Parameters of Laser Generator..... | 45 |
| 7.4 | Technical Parameters of Ultrasound Heads..... | 46 |
| 7.5 | Technical Parameters of Laser Probes..... | 46 |
| 7.6 | Technical Parameters of Laser Clusters..... | 47 |
| 7.7 | Applicable Standards..... | 48 |
| 7.8 | Interconnection of Devices..... | 48 |
| 7.9 | Manufacturer..... | 49 |
| 8 | UNITS CONFIGURATIONS..... | 50 |
| 8.1 | Table of Configurations of the Combined Devices BTL 5000 Combi..... | 50 |
| 8.2 | Table of Configurations of the Electrotherapy Devices BTL-5000 Puls..... | 54 |
| 8.3 | Table of Configurations of the Ultrasound Therapy Devices BTL-5000 Sono..... | 55 |
| 8.4 | Table of Configurations of the Laser Therapy Devices BTL-5000 Laser..... | 55 |

1 GENERAL CHARACTERISTICS

The BTL-5000 series offers advanced and well designed physiotherapy units for professional use. Depending on the required configuration, each system can consist of up to three units -- for electrotherapy, ultrasound or laser therapy treatment.

The touch-controlled display considerably simplifies the use of the unit. The displays are supplied as black and white or colour. The touch screen is equipped with a touch stylus for a more convenient operation. A vertically positioned case of the instrument enables you to see the information on the screen clearly and from different positions. In addition, the display's brightness can be adjusted to fit the light conditions in the office. The information displayed on the screen will guide you throughout the whole therapy. Simply adjust the parameters by pressing the touch screen buttons and turn the main knob to set the intensity.

The modular design of the BTL equipment allows you to build the combination you require. Combine an electrotherapy unit of your choice with either ultrasound or laser or both into a single unit. This can save considerable money on your physiotherapy investment. Alternatively, you may wish to upgrade your unit later, as your needs grow.

Selecting a diagnosis from a list of alphabetically organized treatment protocols, or selecting a program, will make an easy and efficient start of the therapy. Naturally, you can adjust any treatment parameter manually by the simple use of the touch screen buttons. Throughout the whole therapy, the display informs you about the remaining therapy time, channel and therapeutical method used, type of therapy applied, attached accessories, and other necessary data.

If several accessories are attached to your unit at the same time, you can easily recognize the accessory required for a specific treatment. Select a treatment on the display (electrotherapy, ultrasound or laser), and the control light on the corresponding accessory (electrotherapy cable, ultrasound probe, or laser probe/cluster) will switch on to indicate that this accessory should be used.

Save your time by using the pre-programming of the BTL-5000 units. Based on detailed research and practical use of the units, the well-organized pre-programmed protocols will give you recommendations for treating various conditions. The unit also includes up to 500 free lots to define your own protocols. Moreover, you can recall the last 20 treatments.

Add the names of your patients and other relevant information into the unit's internal memory and connect the patient data with pre-programmed or your own protocols. When your patients call again simply recall their name and apply the pre-set therapy.

With every BTL unit, you can purchase a cart specially designed for BTL products. Its versatile design allows you to conveniently store and use 1 or 2 physiotherapy units and a vacuum unit. The cart includes a range of accessory trays and baskets. Four well-built and steady castors ensure easy movement of the unit in the office or in hospital

Please visit our corporate website at <http://www.btl.net.com> for the latest information on BTL products and services.

2 INSTRUCTIONS FOR USE

2.1 FRONT VIEW

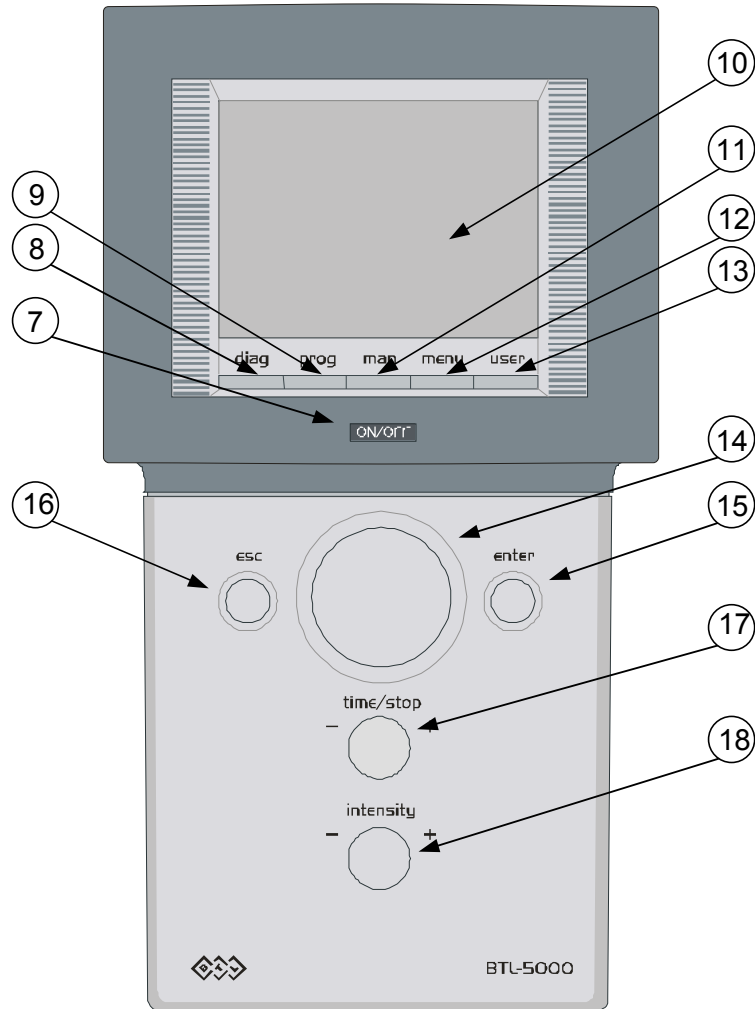

- 1 - 6 line outputs for patient cables on the rear panel, see **2.2 Rear View**
- 7 **ON/OFF** power switch ("ON" status indicated by the blue backlight)
- 8 **diag** button to select diagnosis
- 9 **prog** button to select program number
- 10 touch screen
- 11 **man** button to set therapy parameters manually
- 12 **menu** button to set date, time, language, display contrast, sounds, user options, etc.
- 13 **user** button to work with lists of patients, user diagnoses, programs and sequences, recent therapies and other functions
- 14 **select** knob to select individual parameters
- 15 **enter** button to confirm selection or setting
- 16 **esc** button to cancel selection or setting and return to the original setting
- 17 **time / stop** knob to set therapy time, and to start and stop therapy
- 18 **intensity** knob to set intensity

2.2 REAR VIEW

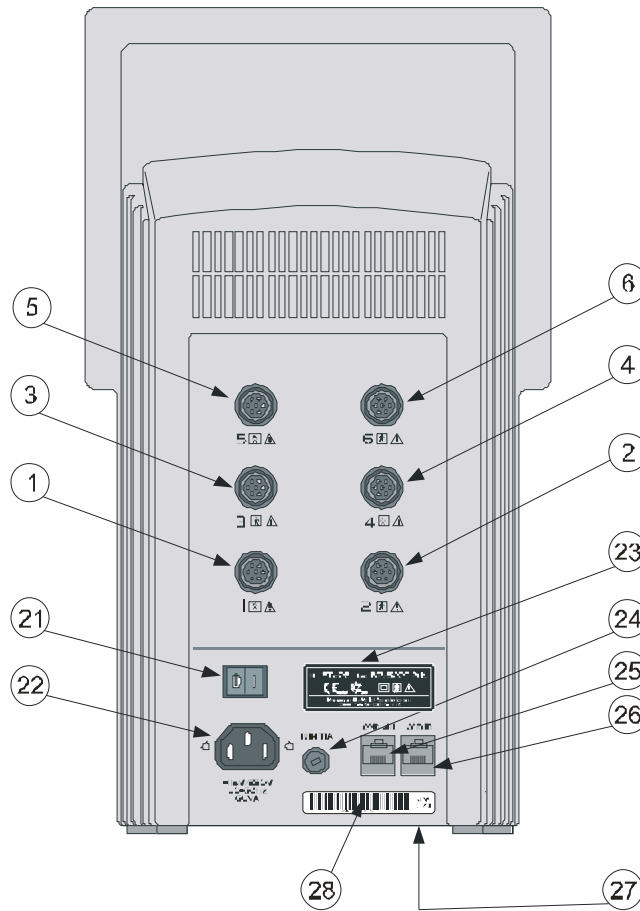

- 1 - 6 patient outputs – for exact configuration see **Tab. 2.1**
- 21 mains switch to switch the power supply on/off
- 22 socket for connection of the mains cable
- 23 label showing equipment type and manufacturer and safety precautions and warnings
- 24 mains fuse receptacle
- 25 in – communication line input
- 26 out – communication line output
- 27 voltage switch 230V / 115V (underneath the chassis)
- 28 label showing serial number and production date

Tab. 2.1 Configuration of output connectors

| Type | Output 1 | Output 2 | Output 3 | Output 4 | Output 5 | Output 6 |
|---------------------------|----------|----------|----------|----------|----------|----------|
| BTL-5110 Laser | | L1A | | L1B | Acup | Door |
| BTL-5120 Laser | L1A | L2A | L1B | L2B | Acup | Door |
| BTL-561x / 5621 Puls* | | | | | E1 | |
| BTL-5620 / 5625 Puls* | | | | | E1 | E2 |
| BTL-563x Puls* | | | E2 | | E1 | E3 |
| BTL-5640 Puls* | | | | | E1A, E1B | E2A, E2B |
| BTL-5660 Puls* | | | E2A, E2B | | E1A, E1B | E3A, E3B |
| BTL-5710 Sono | U1A | | U1B | | E input | E output |
| BTL-5720 Sono | U1A | U2A | U1B | U2B | E input | E output |
| BTL-5800 SL Combi | U1A | L1A | U1B | L1B | Acup | Door |
| BTL-581x / 5621 S Combi* | U1A | | U1B | | E1 | |
| BTL-581x / 5621 S2 Combi* | U1A | U2A | U1B | U2B | E1 | |
| BTL-581x / 5621 SL Combi | U1A | L1A | U1B | L1B | E1 | Door |
| BTL-581x / 5621 L Combi | | L1A | | L1B | E1 | Door |
| BTL-581x / 5621 LL Combi | L1A | L2A | L1B | L2B | Door | E1 |
| BTL-5820 / 5625 S Combi* | U1A | | U1B | | E1 | E2 |
| BTL-5820 / 5625 SL Combi | U1A | L1 | U1B | Door | E1 | E2 |
| BTL-5820 / 5625 L Combi | | L1A | | Door | E1 | E2 |
| BTL-583x L Combi | | L1A | E2 | Door | E1 | E3 |
| BTL-5840 S Combi* | U1A | | U1B | | E1A, E1B | E2A, E2B |
| BTL-5840 SL Combi | U1A | L1 | U1B | Door | E1A, E1B | E2A, E2B |
| BTL-5840 L Combi | | L1A | | Door | E1A, E1B | E2A, E2B |
| BTL-5860 L Combi | | L1A | E2A, E2B | Door | E1A, E1B | E3A, E3B |

* can be supplied or upgraded with HVT module

Notes:

| | |
|-----------------|--|
| E1 | connector for connection of electrotherapy accessories (BTL-236-1, BTL vac) to E1 generator |
| E2 | connector for connection of electrotherapy accessories (BTL-236-1, BTL vac) to E2 generator |
| E3 | connector for connection of electrotherapy accessories (BTL-236-1, BTL vac) to E2 generator |
| E1A, E1B | connector for connection of electrotherapy accessories (BTL-236-2, BTL vac) to E1 generator |
| E2A, E2B | connector for connection of electrotherapy accessories (BTL-236-2, BTL vac) to E2 generator |
| E3A, E3B | connector for connection of electrotherapy accessories (BTL-236-2, BTL vac) to E3 generator |
| E input | connector for electrotherapy input BTL-56xx Puls on the ultrasound for combined therapy |
| E output | connector for electrotherapy output BTL-56xx Puls on the ultrasound for combined therapy |
| L1A | connector for connection of laser probe/cluster BTL-448/BTL-445 (e.g. red) to L1 generator |
| L1B | connector for connection of laser probe/cluster BTL-448/BTL-445 (e.g. infrared) to L1 generator |
| L2A | connector for connection of laser probe/cluster BTL-448/BTL-445 (e.g. red) to L2 generator |
| L2B | connector for connection of laser probe/cluster BTL-448/BTL-445 (e.g. infrared) to L2 generator |
| L1 | connector for connection of laser probe/cluster BTL-448/BTL-445 to L1 generator |
| U1A | connector for connection of ultrasound head BTL-237 (e.g. 1 cm ²) to U1 generator |
| U1B | connector for connection of ultrasound head BTL-237 (e.g. 4 cm ²) to U1 generator |
| U2A | connector for connection of ultrasound head BTL-237 (e.g. 1 cm ²) to U2 generator |
| U2B | connector for connection of ultrasound head BTL-237 (e.g. 4 cm ²) to U2 generator |
| Door | connector for sensor of open door |
| Acup | connector for acupuncture electrode |

How many patients and to which outputs you can simultaneously connect can be seen on the display after pressing the **menu** button in **menu / accessories / connectors - information**.

2.3 UNPACKING AND ASSEMBLY

Inspect the box for damage and report any damage to carrier and your distributor. Do not proceed with installation and assembly if box is damaged.

Unpack the equipment and place it on a stable horizontal surface suitable for the equipment's weight. Always position the unit out of direct sunlight as this may make the touch screen difficult to read. Always position the unit away from direct heat sources such as radiator or room heater. Cooling of the equipment is provided for by forced air circulation. Cooling vents are located on the rear panel and at the bottom of the equipment and must not be covered. Do not position the equipment on a soft surface which may obstruct air flow to the bottom cooling vents. Do not put any heat-producing devices or objects containing water or other liquid on the equipment. Do not place the equipment close to devices producing strong electromagnetic, electric or magnetic field (diathermy, X-rays, etc.), as equipment electronics could be undesirably influenced. In case of questions please call your distributor or service agent.

Retain original packaging to ensure safe transportation of the device.

Attaching the accessory holder:

Remove the protective caps from the holes on a side of the unit. Use a screwdriver to gently slide the blade under the cap and pry it out. Align the accessory holder and secure with screws (supplied) from below. Do not over-tighten.

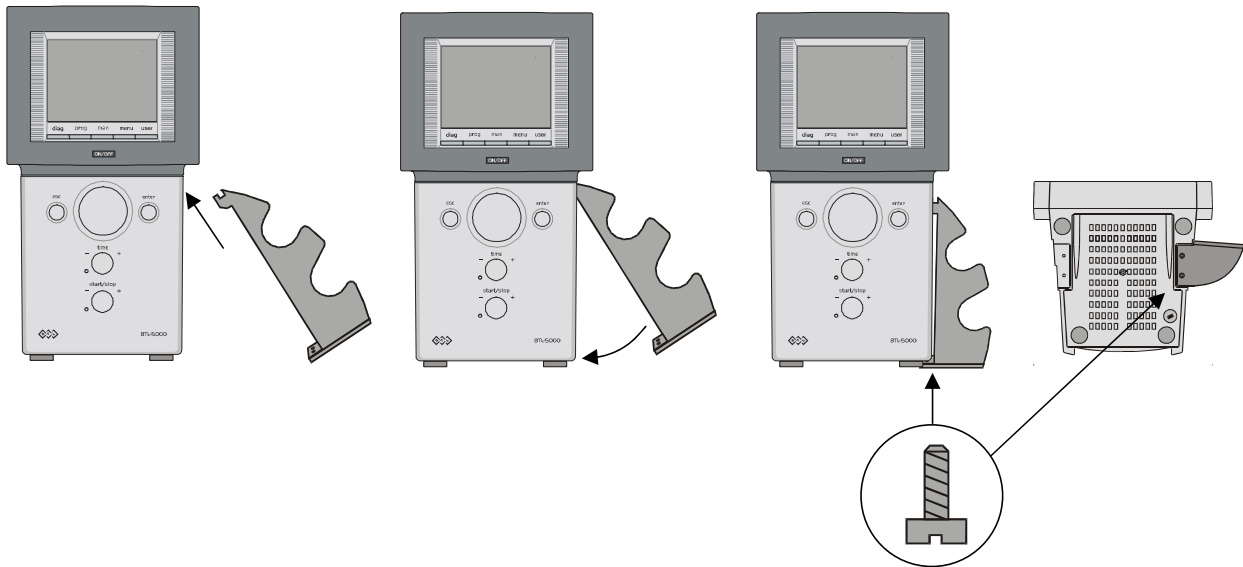

PLUG THE DEVICE DIRECTLY IN THE MAINS SOCKET. DO NOT USE ANY MULTI-CONNECTION EXTENSION CABLE OR ADAPTER.

Check of correct mains voltage:

Before first connection of the equipment to the mains check if the mains voltage switch (27) located at the bottom of the equipment is in the position corresponding to local voltage standards, either in the "230V" or "115V" position. For details, see the note "Switching the equipment to different mains voltage" in **6 MAINTENANCE AND SAFETY INSTRUCTIONS**.

In case of questions please call your distributor or service agent.

Switching the device on:

Plug the mains cable into the mains socket and switch the **O/ I** rocker switch (21) on the rear panel to the **I** position. Press the **ON/OFF** switch (7) on the front panel. The **ON** status is indicated by the backlighting of the switch (7). The system will then run a self-test. If the self-test finds no faults, the screen will display the equipment type and it is ready for use -- see note below.

Connection of accessories:

Connect the accessories to the output connectors (1) - (6) on the rear panel according to the **Tab. 2.1**. The unit will automatically detect their type and display them on the screen. If the wrong device is connected, the equipment will not operate and the screen will display a warning and a help where to connect which accessory.

Note:

After switching on, the unit tests for about 10 - 15 secs all internal functions. If any fault exists the screen will display a warning. If any fault exists that compromises patient safety, the system will 'lock' itself into 'secure' mode. If this situation occurs, please call your local distributor for service advice.

2.4 OPERATING THE UNIT

2.4.1 Touch Screen

The touch screen may be operated by finger touch or use of special soft tip stylus that is supplied with the unit. **DO NOT TOUCH THE SCREEN WITH ANY SHARP OBJECT OR PEN, AS THIS MAY CAUSE PERMANENT DAMAGE.**

Select required parameters by pressing:

1. 3D buttons
2. Bright tabs of the selected channel (in the lower left corner of the screen) to switch between connected accessories, such as ultrasound heads
3. The dark tab of the required channel (in the lower left corner of the screen) to switch between channels

Touch screen buttons:

The touch screen buttons have three dimensional (3D) shading and may be pressed with the finger or special stylus. To confirm requested changes or values, press **enter**. To cancel changes, press **escape**.

Selected channel:

Although most of the configurations allow running of several therapies at a time, only one channel can be controlled at once. The tab of this selected channel is shaded light. All information on the screen and all controls relate to this channel. The most important information about the therapies on the other channels is visible on their tabs.

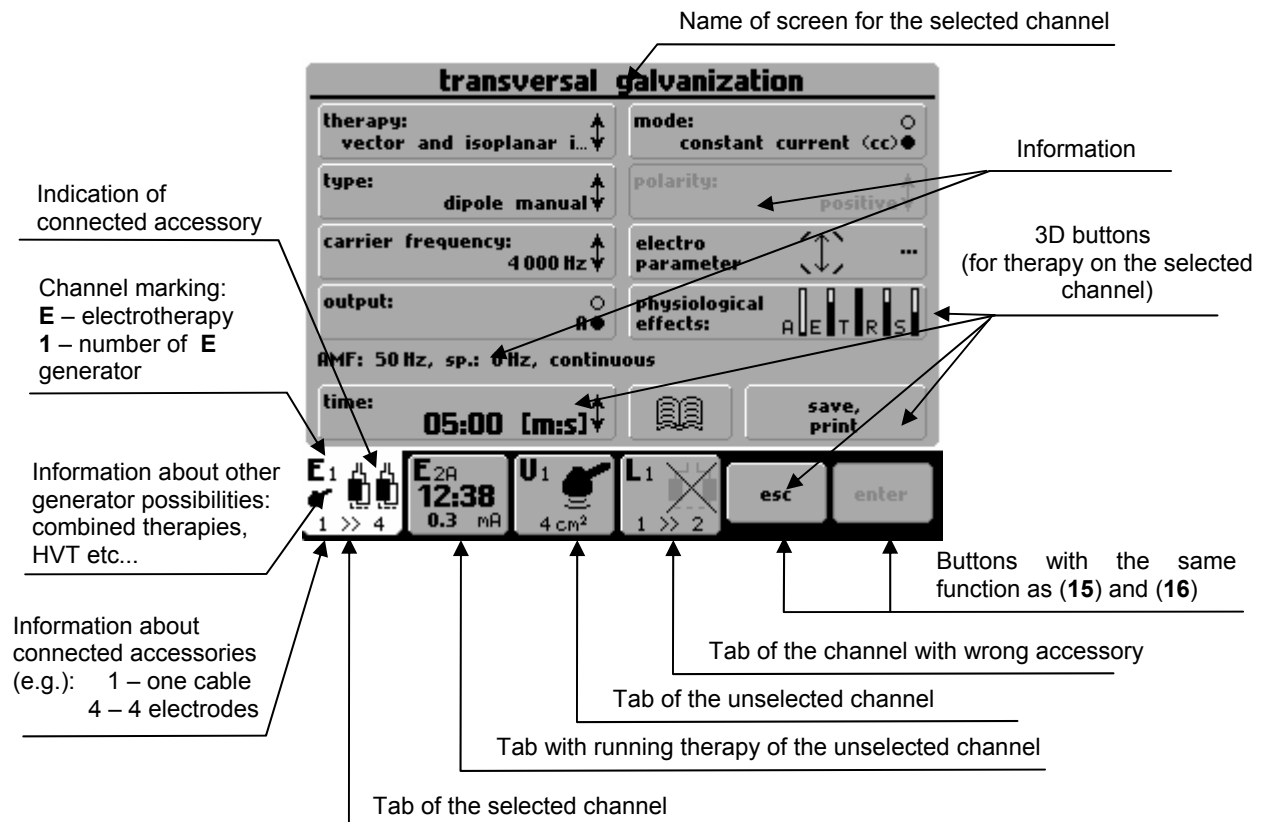

2.4.2 Numerical Keyboard

In addition to setting numerical value with the **select (14)** button, you can also use “numerical keyboard”.

Press this icon to open window with numerical keyboard:

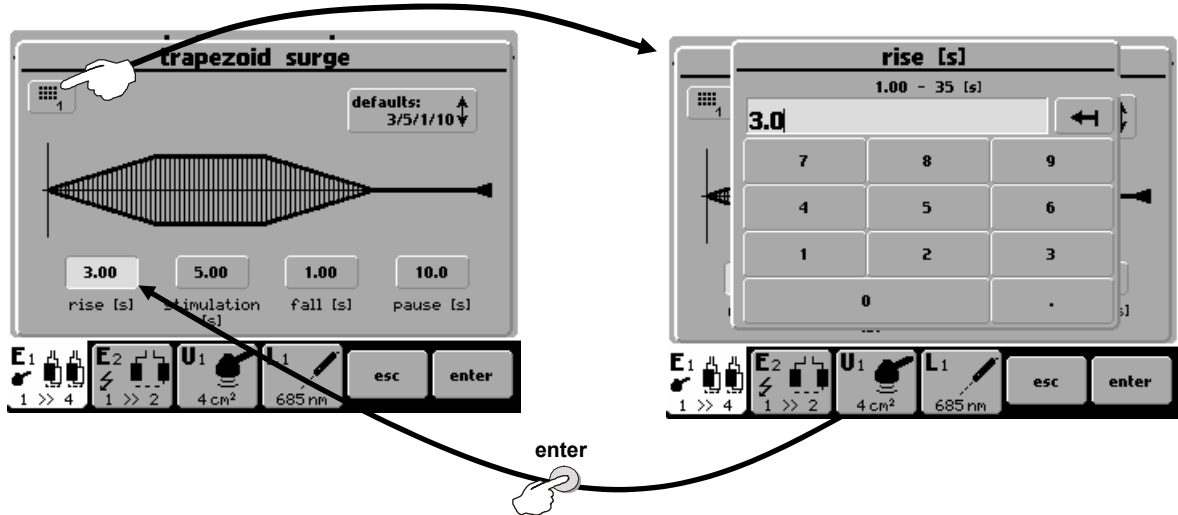

Set numerical values of the parameter that has been selected - “white” button on the picture above. Enter the value and press **enter (15)** to return to original screen. Press **esc (16)** to exit the screen. If you set the value that exceeds the allowed value range (allowed value range is stated on top of the screen), or if the unit cannot set the required value, the value will be rounded as close as possible to the allowed value.

2.5 THERAPY SETTING

2.5.1 Therapy Flow Chart

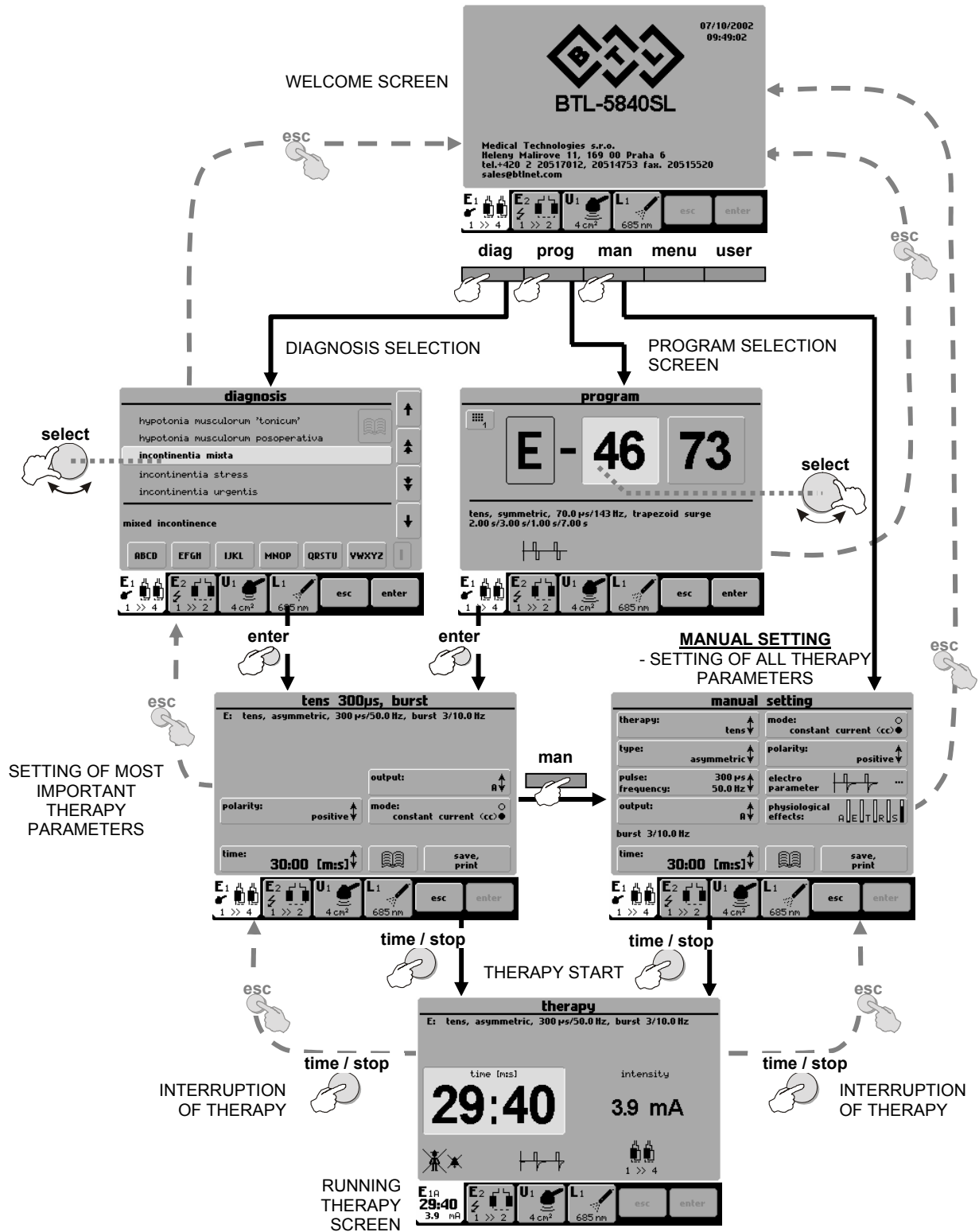

2.5.2 Welcome Screen and Selection of Channels, Tabs and Accessories

The welcome screen, accessed upon power up, displays channel tabs and icons showing which accessories are connected. The number of channels displayed depends on the unit configuration. The following diagram shows that almost the entire display is available for the selected channel.

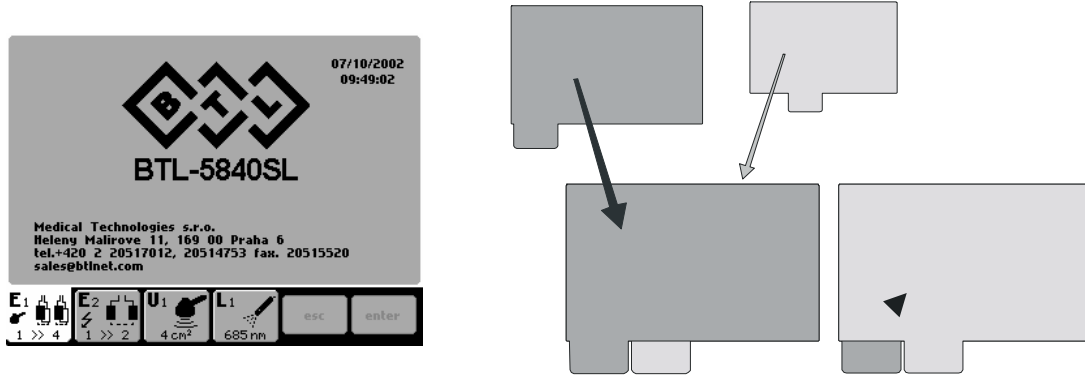

If more accessories are connected to one generator (e.g. two ultrasound heads connected to a single ultrasound generator), pressing the channel tab of the generator will switch between accessories.

The colour of the selected channel tab is white.

Examples of information on tabs:

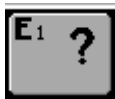

Tab of channel E1 which is not selected and has no accessories



Tab of selected channel E2 with the possibility to apply HVT therapy and with electrotherapy accessory BTL-236-1 with two electrodes



Tab of channel E1 with electrotherapy accessory BTL-236-1 and possibility to apply **combined therapy**



Tab of channel E2 with electrotherapy accessory BTL-236-1 and possibility to apply **combined** and **HVT therapies**

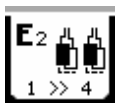

Tab of selected channel E2 with electrotherapy accessory BTL-236-2.

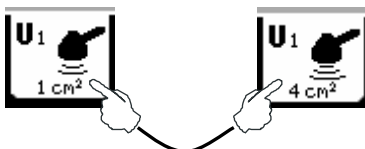

Tab of selected generator U1 with connected ultrasound heads. Press the tab to switch between the 1cm² and 4cm² heads.



Tab of selected generator L1 with connected laser probes. Press the tab to switch between the 685nm and 830nm probes.



Tab of selected channel E2 with wrong accessory.

2.5.3 Setting Therapy Parameters via the 'diag' Button

Press the **diag** (8) button to display a list of therapy protocols / diagnoses. Each channel tab has its own list of therapy protocols. For example, the channel tab of ultrasound generator includes the list of therapy protocols for ultrasound treatment. If the tab depicts a HVT or combined therapy symbols (see Chapter 2.5.2 Welcome Screen and Selection of Channels, Tabs and Accessories), the list includes protocols for HVT or combined therapies.

To find a therapy protocol fast, press the button with the starting letter of the protocol required. The selected letter depends on how many times the button is pressed. For example, after pressing the **MNOP** button once, there are listed protocols starting with the first letter, **M**. Pressing **MNOP** twice = **N**, three times = **O** and four times = **P**. The currently selected letter is displayed in the box to the left of the buttons.

To select the found required diagnosis press the **enter** button (15). If the protocol has more therapies they are listed after selecting the protocol.

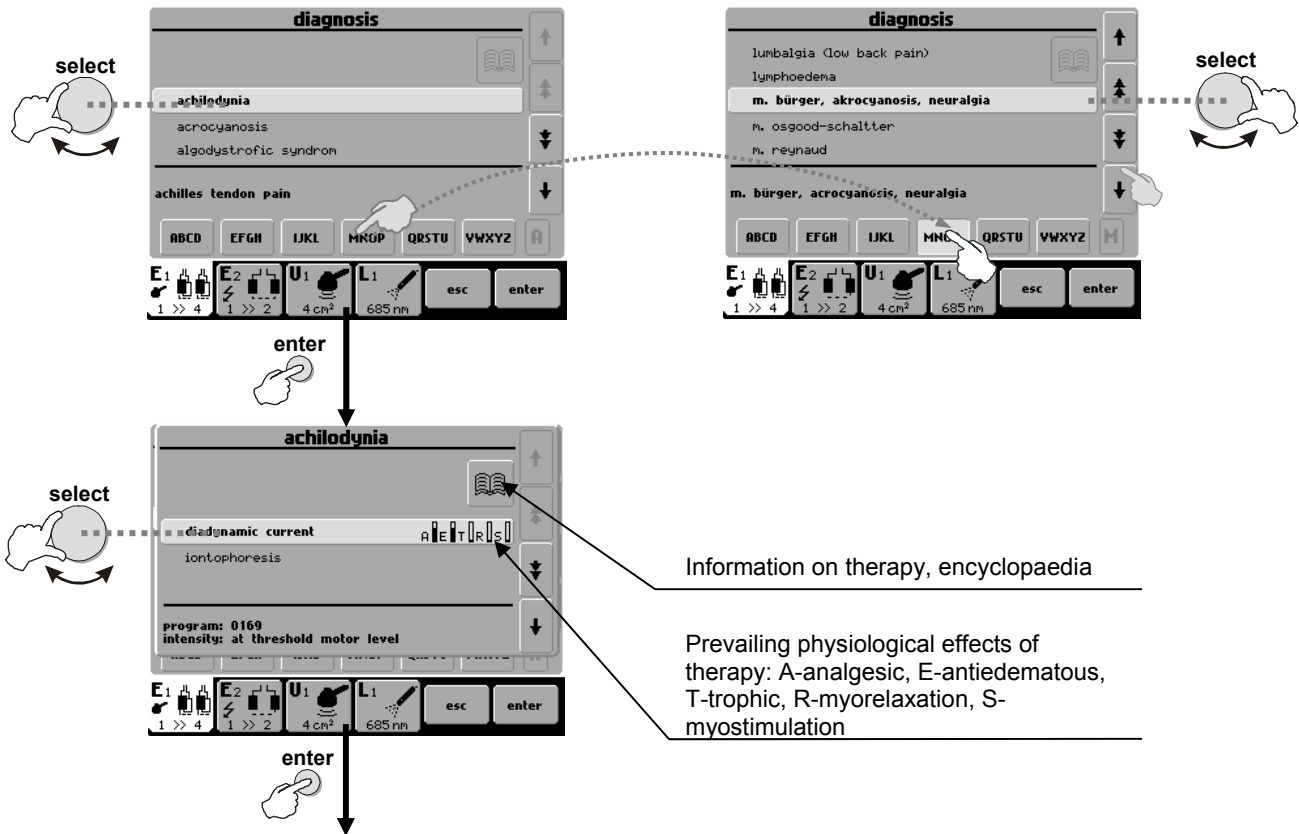

See 2.5.6 Therapy Parameters Screen – Ergonomic, Standard and Expert Mode

Your own protocols can be easily recognized by the 'card' icon in front of the name of the protocol.



2.5.4 Setting Therapy Parameters via the 'prog' Button

Press the **prog** (9) button to set the required program number. The program numbers generally correspond to the program numbers used in the traditional BTL physiotherapy line. A letter in front of each number corresponds to the type of therapy selected: **E** – electrotherapy; **U** – ultrasound; **L** – laser.

Combined therapies E+U are listed among **E** programs and can be found on the electrotherapy tab with the symbol of ultrasound head (see Chapter 2.5.2 **Welcome Screen and Selection of Channels, Tabs and Accessories**). They are on the positions **E-35xx - E-39xx**.

Your own therapy protocols (except sequences) can be saved under the following numbers: **E-80xx - E-89xx** for electrotherapy, **U-80xx - U-89xx** for ultrasound therapies, and **L-80xx - L-89xx** for laser therapies.

Your own sequences are saved under the following numbers: **E-95xx - E-99xx** for electrotherapy, **U-95xx - U-99xx** for ultrasound therapies, and **L-95xx - L-99xx** for laser therapies.

Programs recommended for diagnoses can be found in the User's Guide.

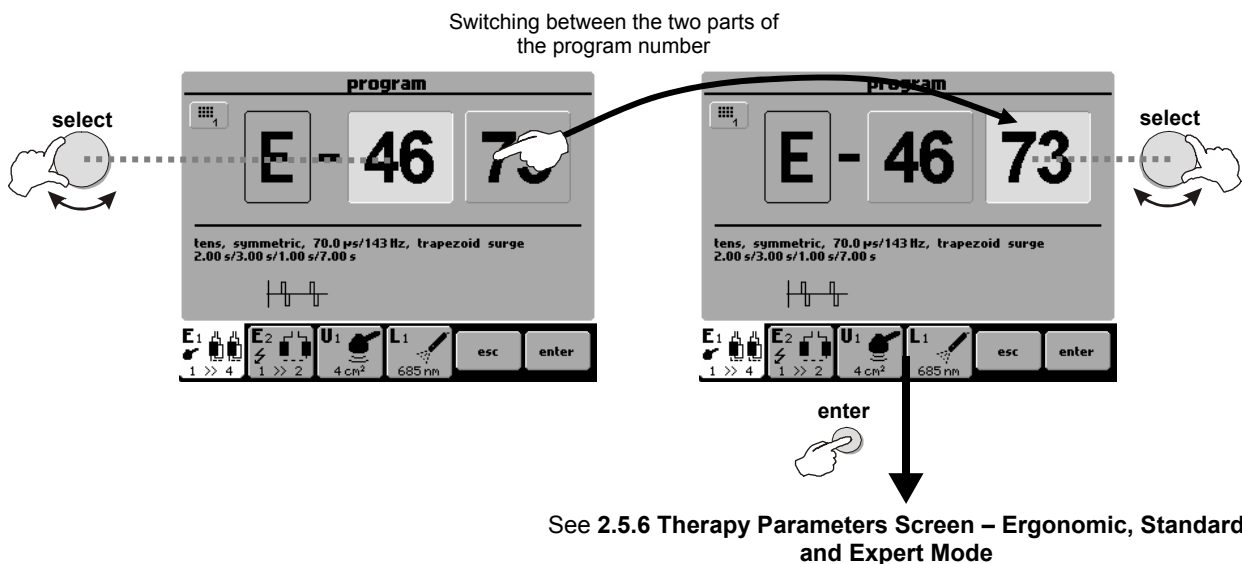

For fast program number selection, use numerical keyboard. See chapter 2.4.2 **Numerical Keyboard** for details.

2.5.5 Setting Therapy Parameters Manually via the 'man' Button

Press the **man** (11) button to select manual setting for therapy. You may store manual settings for use at a later time.

Press individual 3D buttons to open menus and setting screens. The majority of screens are accompanied by illustrating pictures and symbols. See the example below:

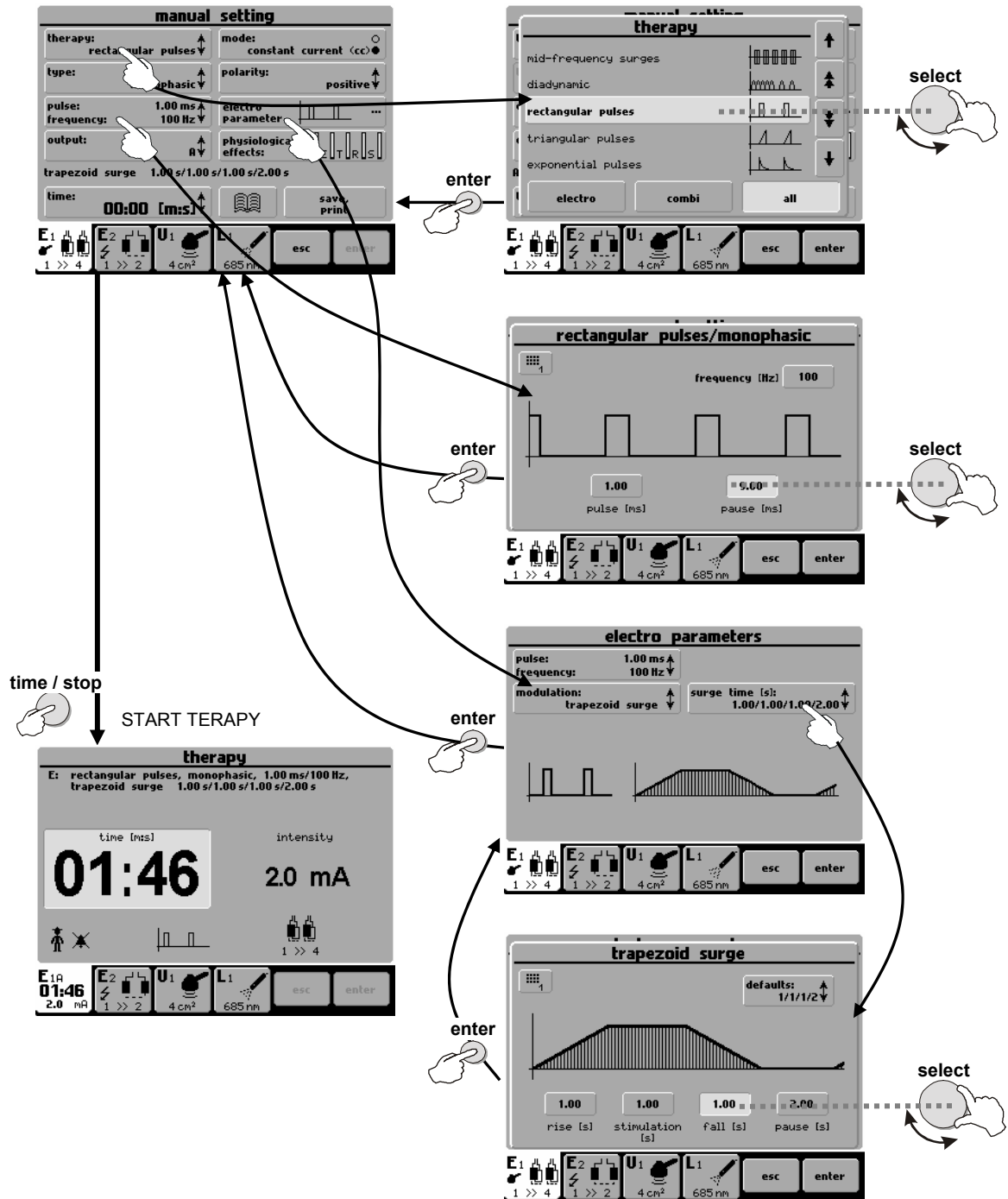

2.5.6 Therapy Parameters Screen – Ergonomic, Standard and Expert Mode

This screen opens after pressing the **diag** (8) or **prog** (9) button (see 2.5.1 Therapy Flow Chart) before the start of therapy. The screen shows either the most important therapy parameters (you have selected the ergonomic mode) or all information about therapy (you have selected expert or standard mode). In addition, in expert mode you can modify all parameters.

The differences between modes are best seen here:

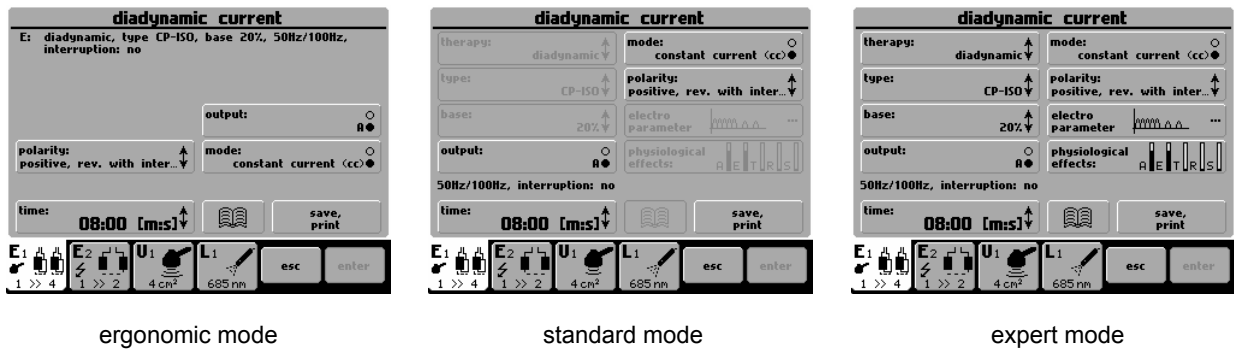

ergonomic mode

standard mode

expert mode

Set the operation mode via the **menu** (12) button - refer to Chapter 3.2.8 Operation Mode for details. For a fast switch to expert mode from any other operation mode, press **man** (11) button.

2.5.6.1 Setting Therapy Time

Press the **time** screen button on the therapy parameters screen to set the required time. For fast settings, use the **time / stop** (17) knob.

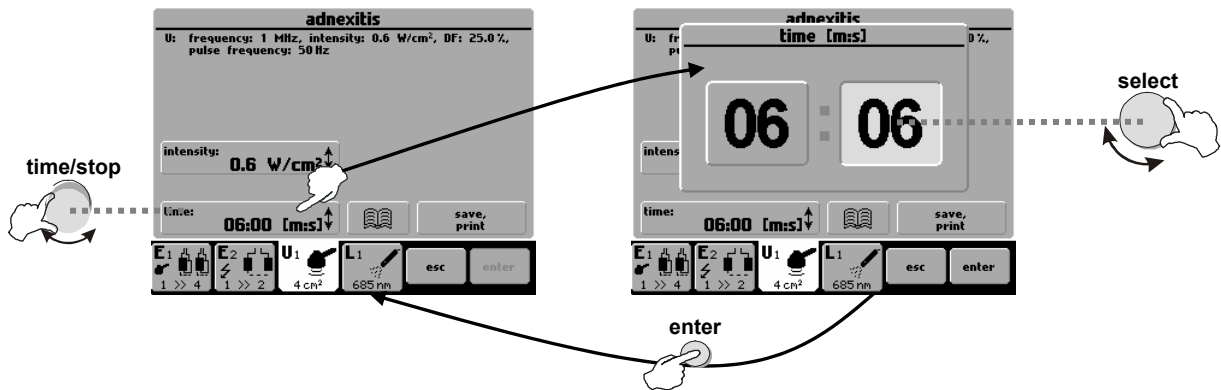

2.5.6.2 Setting Intensity

Ultrasound and laser therapies: intensity (output) can be set only on the therapy parameters screen and only when the therapy is not running. To set the intensity, press the **intensity** screen button or turn the **intensity** (18) knob.

Electrotherapy: Intensity is set during therapy and can only be adjusted by turning the **intensity** (18) knob.

For faster intensity setting, keep the **intensity** (18) knob pressed down while turning it .

2.6 COURSE OF THERAPY

2.6.1 Start, Interruption and End of Therapy

To start therapy on the selected channel, press the **time / stop** (17) knob. The therapy can start only if the therapy parameters screen is displayed.

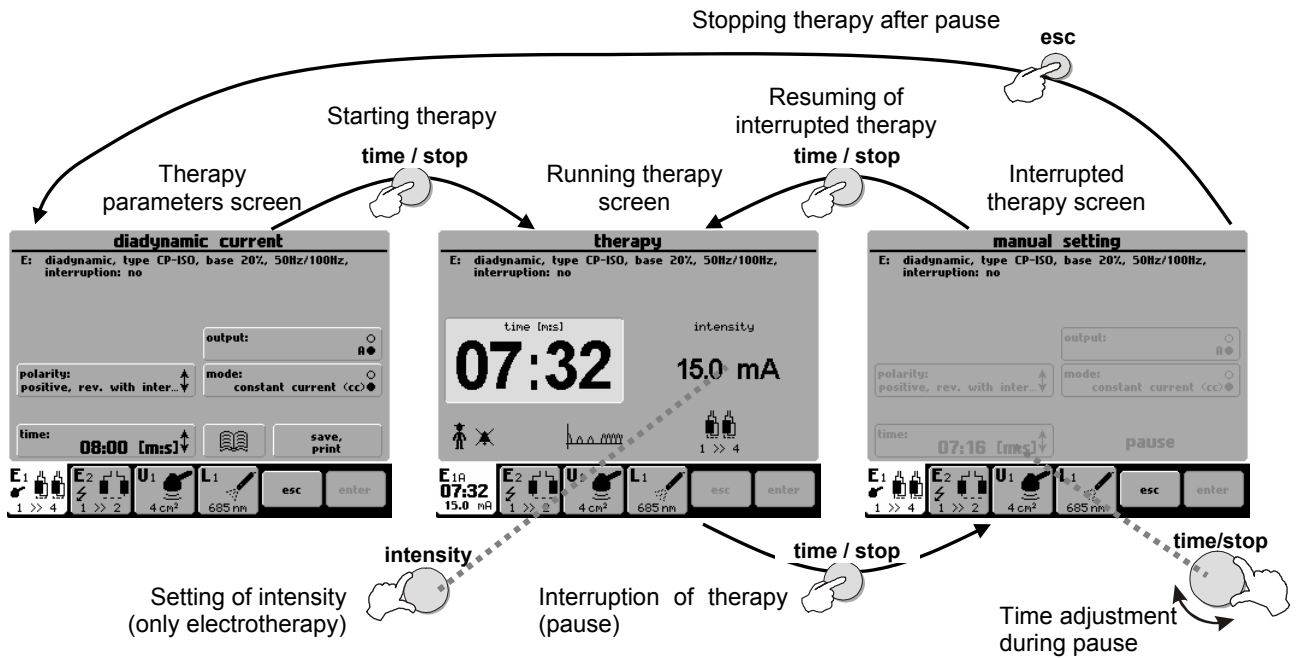

Interrupted therapy can be resumed by pressing the **time / stop** (17) knob or stopped by pressing the **esc** (16) button.

During therapy interruption, you can adjust the time (except for laser therapies and all types of sequences) by the **time / stop** (17) button.

During **electrotherapy**, you can adjust the intensity during therapy by turning the **intensity** (18) knob to the right (to increase intensity) or to the left (to decrease intensity). For faster intensity setting, keep the **intensity** (18) knob pressed down while turning it left or right.

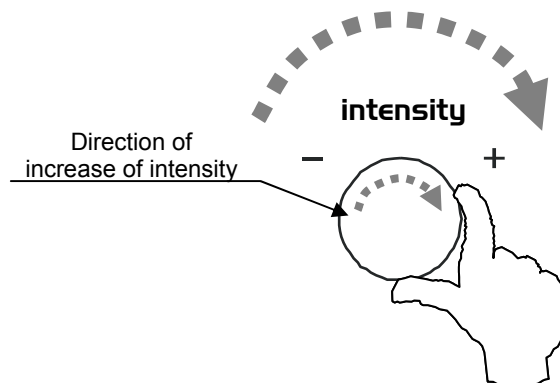

Laser therapy can also be started / interrupted by the **start / stop** button on the laser probe.



2.6.2 Running Therapy Screen

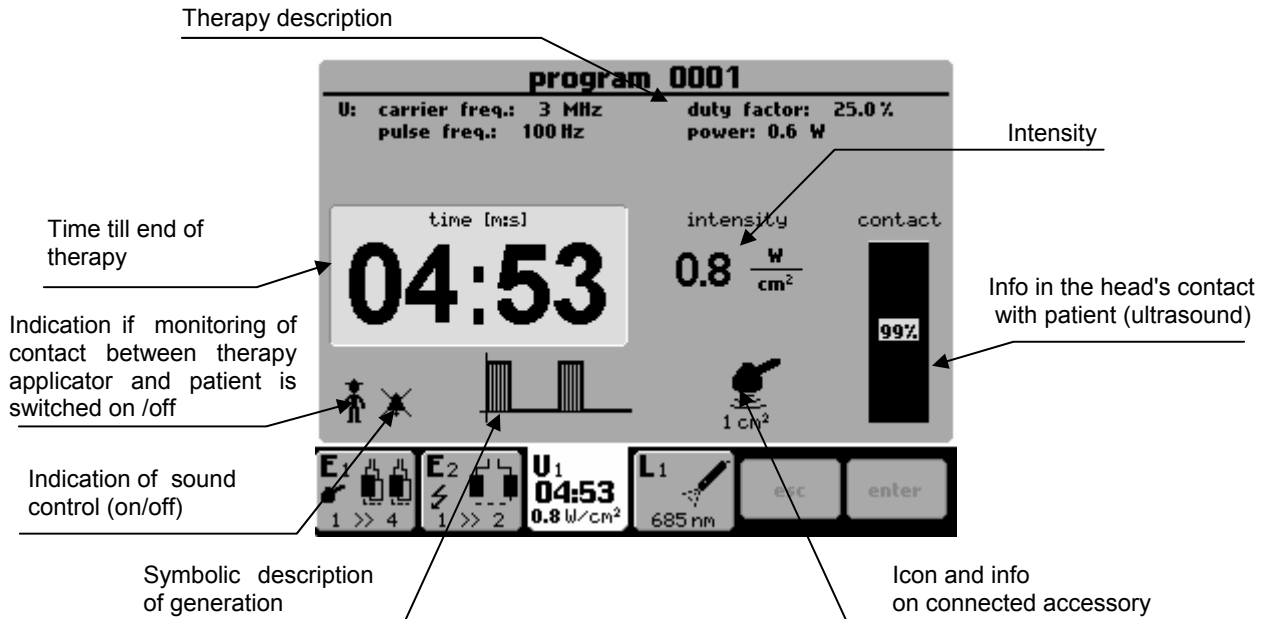

2.6.3 Electrotherapy – Settings during Therapy

2.6.3.1 Setting the Intensity in 4-electrode Therapies

Making a therapy with four electrodes, you can set different intensities between each pair of electrodes. In case of 4-pole interference the output intensity is set by the **intensity (18)** button on both channels at the same time (the screen button 1+2 is pressed) or on each channel separately (the screen button 1 or 2 is pressed).

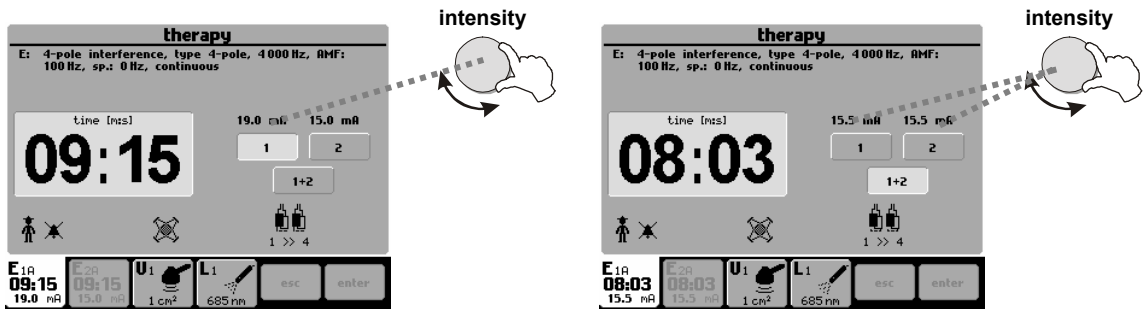

If the intensity on one of the channels is set to zero, the therapy is terminated.

2.6.3.2 Manual Control of Vector in Dipole Interference

Dipole angle is set manually by the **select (14)** button during therapy. Dipole position is schematically displayed on the screen below time value.

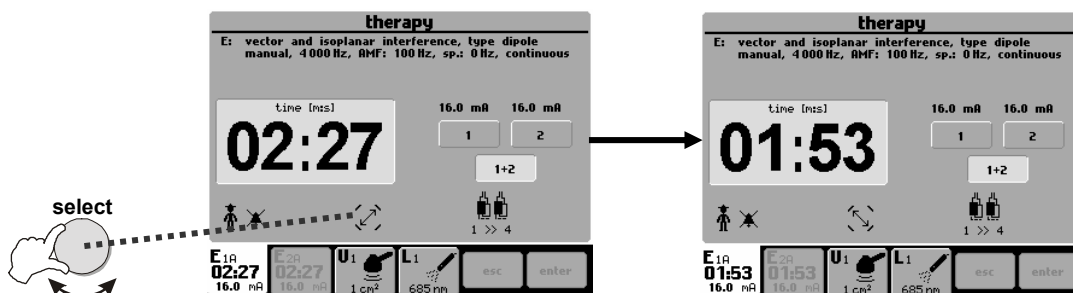

When rotating dipole, the unit automatically switches to diagnostic mode (Spectrum value = 0Hz). After 1 or 2 seconds the unit returns to therapeutic mode (Spectrum value = preset value).

2.6.4 Accessories – Visual Signaling

Accessories BTL-236 (for electrotherapy) and BTL-237 (ultrasound heads) feature blue pilot lights that signal their operating conditions.



BTL-236-1: patient cable with two electrodes. Blue pilot light signals:

- **Slow blinking** – accessories prepared for therapy, therapy settings screen displayed
- **Solid light** – therapy in process, possible dangerous voltage on electrodes



BTL-236-2: patient cable with four electrodes. Blue pilot light signals:

- **Slow blinking** – accessories prepared for therapy, therapy settings screen displayed; pilot light blinks on a pair of selected electrodes
- **Blinking in rhythm of generated currents or solid light** – therapy in process, possible dangerous voltage on electrodes with pilot light blinking



BTL-237: ultrasound head of 1 cm² or 4 cm². Blue pilot ring signals:

- **Slow blinking** – accessories prepared for therapy, therapy settings screen displayed
- **Solid light** – therapy in process
- **Rapid blinking** – wrong contact of head with patient's tissue, therapy paused; contact must be re-established to continue therapy



BTL-448: laser probes: red and infrared – green pilot light and focusing beam:

- **Blinking in rhythm of generated laser or solid light** – laser irradiation (also indicated by acoustic signal)

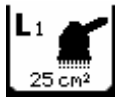

BTL-445: laser clusters: red, infrared and combined – focusing beam:

- **Blinking in rhythm of generated laser or solid light** – laser irradiation (also indicated by acoustic signal)

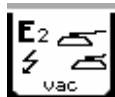

BTL vac: vacuum unit for electrotherapy – see separate manual

For detailed information, please refer to the leaflet enclosed with each accessory supplied.

2.6.5 Indication of Operation – Energy on Output

2.6.5.1 Electrotherapy

Presence of electrotherapy voltage on output is indicated:

- on the screen – by value of intensity of output current
- on the screen – by showing the remaining time till the end of therapy
- on the screen – by icon of running electrotherapy current
- on the channel tab – by value of intensity and time
- on the electrotherapy accessory BTL-236 – by blue pilot light

Disconnection of electric circuit (such as in case of wrong contact between electrode and patient) is indicated by blinking information about intensity and time on the corresponding channel tab, or by audio signaling.

This function can be switched on and off in the menu of the unit. Its current state is marked by a figure symbol (crossed-out if disabled). Audio signaling can be switched on and off -- marked by a bell symbol on the screen (crossed-out if disabled).



2.6.5.2 Ultrasound Therapy

Generation of ultrasound energy by ultrasound head BTL-237 is indicated:

- on the screen – by value of intensity
- on the screen – by bar-graph showing contact of head with tissue
- on the screen – by time value showing the remaining time till the end of therapy
- on the screen – by icon of ultrasound head and icon of signal type
- on the channel tab – by value of intensity and time
- On the ultrasound accessory BTL-237 – by blue light ring



Insufficient contact between the ultrasound head and the tissue is indicated by rapid blinking of the blue light ring on the head and blinking of the information on intensity and time on the channel tab of the corresponding ultrasound generator.

This function is indicated by a figure symbol on the screen.

Acoustic indication is signaled by a symbol of bell. (If the function is disabled, the bell is crossed-out.)

2.6.5.3 Laser Therapy

Laser irradiation by BTL-448 laser probe is indicated:

- on the screen – by intensity value
- by acoustic signal (cannot be disabled)
- on the screen – by time value showing the remaining time till the end of therapy
- by green pilot light on laser probe
- by green or red beam
- on the screen - by icon of laser probe and signal
- on the channel tab – by value of intensity and time

Laser irradiation by BTL-445 laser cluster is indicated:

- on the screen – by intensity value
- by acoustic signal (cannot be disabled)
- on the screen – by time value showing the remaining time till the end of therapy
- by blue focusing beam
- on the screen - by icon of laser cluster and signal
- on the channel tab – by value of intensity and time

2.7 THERAPY PARAMETERS

Therapy parameters vary. Only the parameters are displayed that characterize the therapy and that can be set in manual mode – by pressing the **man** button. For detailed description of parameters for individual therapies refer to the **User's Guide**.

2.8 ENCYCLOPAEDIA

The encyclopaedia provides information about individual therapies, examples of electrode placement and application areas for ultrasound and laser. Each unit is supplied with a hard copy of encyclopaedia. Its electronic format is included in the unit, and is available from most screens and menus.

Note: Treatment protocols and related information are only a guide and are not intended as a replacement for good clinical judgment and experience!

Press this icon to open **encyclopaedia**:



Opening the encyclopaedia after selection of a treatment protocol will give you information about the selected protocol. Otherwise, you will enter the encyclopaedia contents – move between the diagnoses using the **select (14)** button. Select a diagnosis and press the **enter (15)** button to get required information:

Information about diagnosis

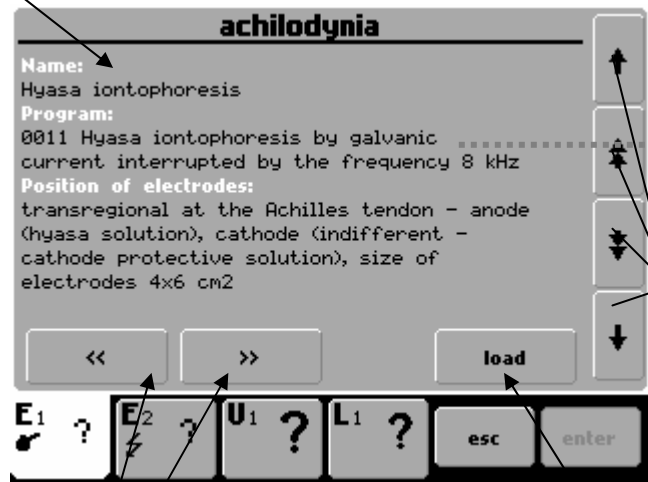

select

Moving between information if not on one screen

Moving between diagnoses

Loading parameters of selected diagnosis to the parameters screen - unit is ready to start therapy

2.9 THERAPY PRINTING AND SAVING

Pressing the **print, save** button allows you to make several choices. Simply complete the form by entering the required data filed as shown on the screens below.

2.9.1 Save Therapy

You can save your therapy after setting therapy parameters from the **therapy parameters screen** –see Chapter 2.5.6 **Therapy Parameters Screen – Ergonomic, Standard and Expert Mode.**

The following information is saved with each therapy:

Electrotherapy:

- All parameters of currents (pulse length, pause length, modulation, etc.)
- Therapy time
- Polarity
- Output mode (current / voltage)*

Ultrasound therapy:

- All therapy parameters (for example, ultrasound frequency, duty factor - DF, pulse frequency, etc.)
- Therapy time
- Intensity

Combined therapies electro + ultrasound:

- All electrotherapy parameters (pulse length, pause length, modulation, etc.)
- All ultrasound therapy parameters (ultrasound frequency, duty factor - DF, pulse frequency, etc.)
- Therapy time
- Polarity of electrotherapy output
- Electrotherapy output mode (current / voltage)
- Intensity of ultrasound*

Laser therapy:

- All therapy parameters (frequency, course of signal, etc.)
- Irradiated area
- Dosage

* output intensity can be entered into a comment (e.g. at threshold motor level)

When saving therapy, enter:

- Name of diagnosis (therapy) – to be displayed in the list of diagnoses - the **diag (8)** button
- Name of program – to be displayed in the list of programs - the **prog (9)** button
- Description, additional information – to be displayed in both lists

The unit suggests the lowest available number (from the range of 8000-8999) and adds the letter of the corresponding generator (E for electrotherapy and combined therapies, U for ultrasound therapies, and L for laser therapies).

2.9.2 Save Therapy and Add It to the Patient Data

The therapy is saved as described above and assigned to the patient in their list of therapies.

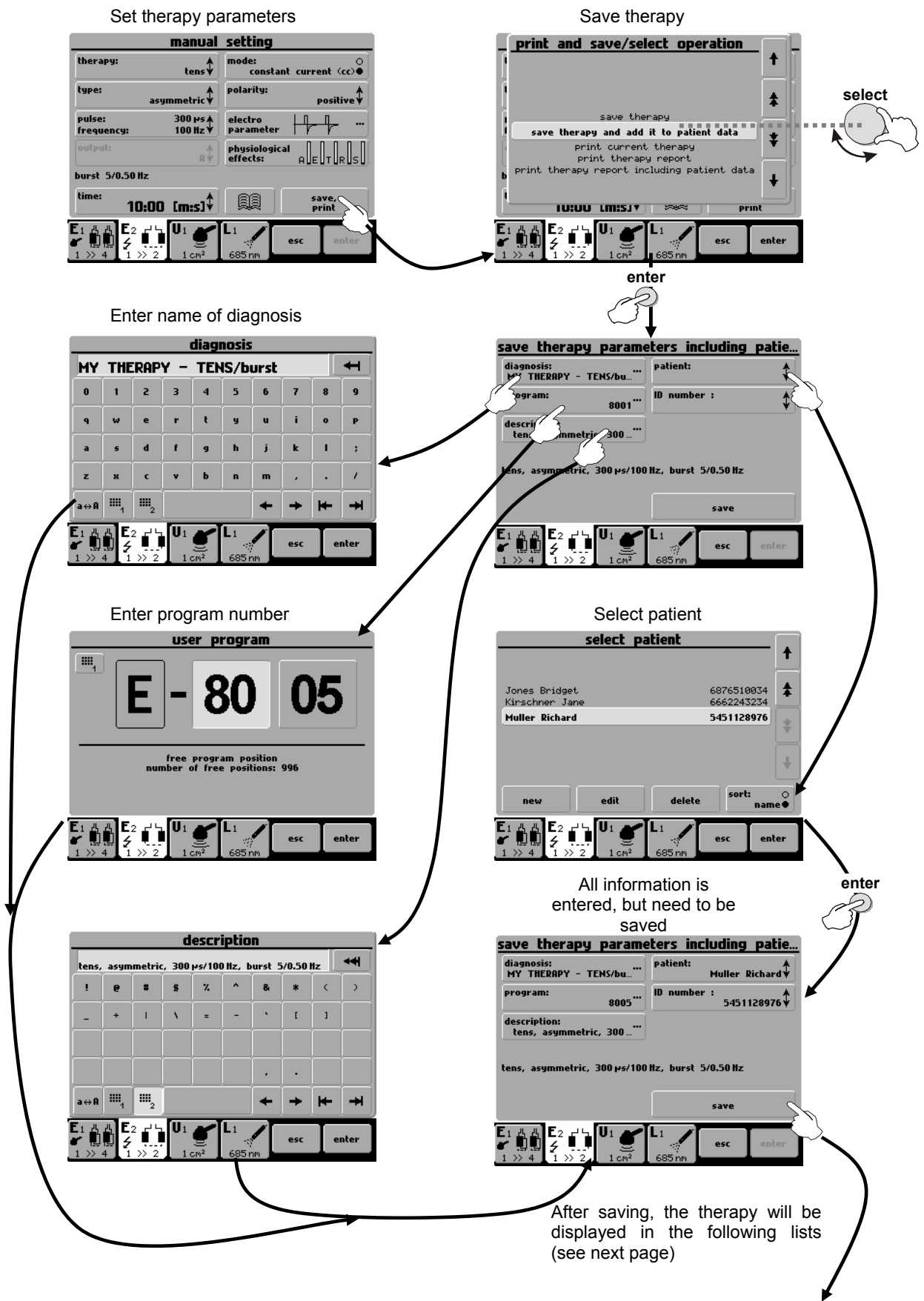

A saved therapy will be visible in the:

List of diagnoses

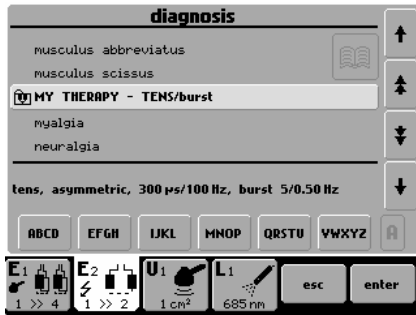

List of programs

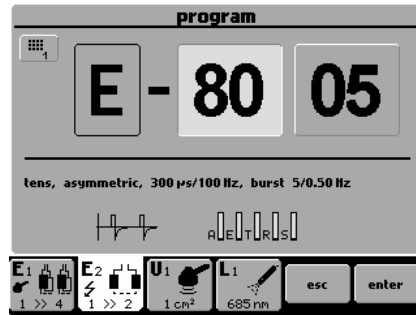

and in the list of therapies of the selected patient

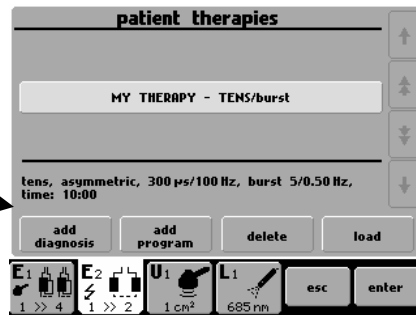
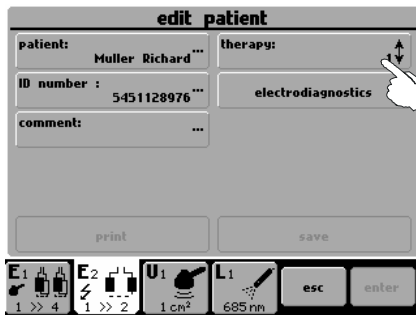

2.10 INTERCONNECTION OF UNITS

2.10.1 Interconnection of BTL-5000 Puls (Combi) and Vacuum Unit BTL vac

Combine any **BTL-5000 Puls** or **Combi** unit with the vacuum unit **BTL vac** to apply electrotherapy currents by means of suction cup electrodes. Adjustable vacuum pressure ensures simple and convenient attachment of patient electrodes, especially on the parts of body hard to reach with classic electrodes. Moreover, the pulse mode provides mechanical massage of the tissue, improves body metabolism and increases blood supply.

The electrotherapy unit has its outputs connected with the vacuum unit. Both vacuum and flat electrodes are attached to the vacuum unit. Each channel on the vacuum unit has a switch. When the switch is on, current is brought to the vacuum electrodes. When the switch is off, current is brought to the standard electrodes.

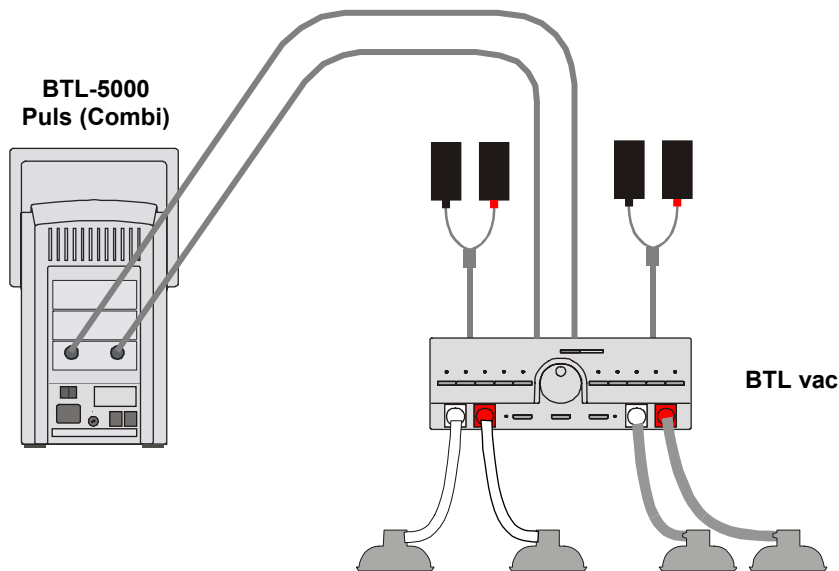

(the pictures serve only as an illustration, for actual interconnection follow the table **Tab. 2.1 Configuration of output connectors**)

For interconnection, use the interface cables leading from **BTL-5000 Puls** outputs **E1** and **E2** and connected to **BTL vac** inputs **IN1** and **IN2**. See the **BTL vac** manual for details.

2.10.2 Interconnection of BTL-5000 Puls and BTL-5000 Sono

If combined therapy is used, connect the ultrasound and electrical stimulation units together.

| Electrotherapy unit BTL-56xx Puls | | Ultrasound unit BTL-5710 Sono | |
|-----------------------------------|--------------------------------|-------------------------------|------------------------------------|
| Connector | Connected accessories | Connector | Connected accessories |
| E1 | Interface cable for ultrasound | U1A | 1 cm ² ultrasound head |
| E2* | electrodes E2* | U1B | 4 cm ² ultrasound head |
| E3* | electrodes E3* | E input | Interface cable for electrotherapy |
| | * if they are available | E output | electrodes E1 |

Setting polarity between ultrasound head and electrode

After interconnection with the electrotherapy device, the ultrasound head becomes the anode (+). The other pole is cathode (-) which is the electrode with black banana plug. If the ultrasound head is required to be the cathode (-) during combined therapy, select 'negative polarity' in the therapy parameters screen of the electrotherapy unit.

To apply electrotherapy only with interconnected units, cancel the choice 'interconnection with electrotherapy' on the BTL-5000 Sono screen. The electrotherapy electrodes are automatically connected to the electrotherapy output.

2.10.3 Interconnection of BTL-5000 Puls, BTL-5000 Sono and BTL vac

To connect the three units, follow this diagram:

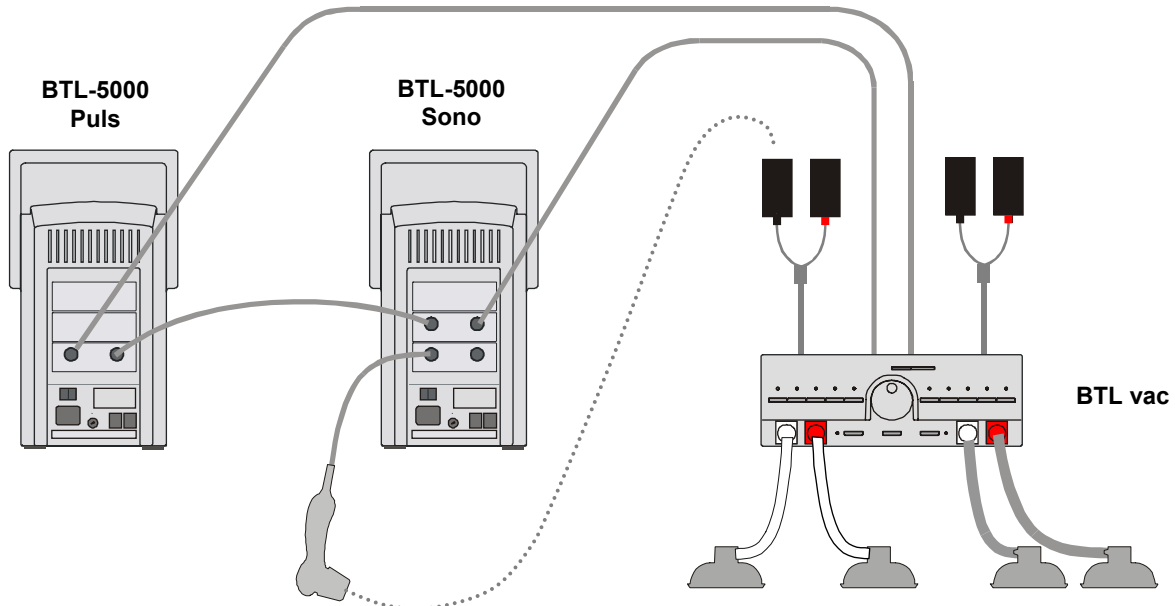

(the pictures serve only as an illustration, for actual interconnection follow the table below and the table **Tab. 2.1 Configuration of output connectors**)

| Electrotherapy BTL-56xx Puls | | Ultrasound BTL-5710 Sono | |
|------------------------------|-----------------------------------|--------------------------|------------------------------------|
| Connector | Connected accessories | Connector | Connected accessories |
| E1 | Interface cable for BTL-5000 Sono | U1A | 1 cm ² ultrasound head |
| E2* | Interface cable for BTL vac (IN2) | U1B | 4 cm ² ultrasound head |
| E3* | electrodes | E input | Interface cable for electrotherapy |
| | * if available | E output | Interface cable for BTL vac (IN1) |

2.10.4 Setup and Operation of Combined Therapy in Single Devices

After checking for correct interconnection of the electrotherapy and ultrasound units, select a diagnosis or program that utilizes combined therapy. Select these separately on the electrotherapy and on the ultrasound units. Set the electrotherapy unit to CV mode. Then attach the respective electrode to the patient to close the electric circuit ultrasound head-patient-electrode (see the above diagrams). It is now possible to run the ultrasound by the **time / stop** button. Position the ultrasound head in contact with tissue and notice that the timer commences counting down. Slowly increase intensity on the electrotherapy by turning the **intensity** button to the right in the "+" direction. Combined therapy is now running. If the contact between the ultrasound head and the treated tissue during the therapy was not continuous, the times shown on both devices can differ, because timer countdown on the ultrasound device does not run when contact is interrupted.

2.10.5 Stopping Combined Therapy in Single Devices

Delivery of combined therapy ends after expiration of the set time on both units' timer devices. To stop or interrupt therapy before the set time expires, it is necessary first to interrupt the therapy on both units by pressing the **time / stop** buttons.

3 MENU BUTTON

Press the **menu (12)** button and scroll through the following options:

- accessories
- encyclopaedia – see Chapter **2.8 Encyclopaedia**
- unit settings
- special settings

3.1 ACCESSORIES

Select:

- installation of accessories and
- information about connected accessories
- information about the number of patients and connection of connectors on the rear panel of the device

3.1.1 Installation of Accessories

Each connected accessory has the memory that includes identification data of this accessory. According to these data, the unit recognizes which accessory is connected, if it is compatible or not, if the unit can work with the connected accessory or not. The memory also contains serial number of the accessory. This memory contains a lot of information and their reading lasts from 30 seconds to 2 minutes. The installation of accessories serves for faster work of the unit. After the installation, only the serial number of the accessory is read from the accessory memory and the other information is read from the unit's memory.

During the installation process, follow the instructions on the screen. In particular:

- switch off all therapies
- do not have connected other accessories than the one that is being installed. Make sure the installed accessory is connected directly, not via interface cable and vacuum or BTI-5000 Sono devices.

This will help decrease electromagnetic interference that could cause improper reading of memory data.

3.1.2 Information about Accessories

Allows identification of connected accessories (name, serial number, for which generator - output / input - the accessory has been designed).



3.1.3 Connectors - Information

This menu item will inform you about the way of connection of the connectors on the rear panel of the device and to how many patients you can connect the device safely.

3.2 UNIT SETTINGS

Provides a list of settings of parameters and user preferences:

- Password setting
- Audio tones setting
- LCD screen saver and auto power off
- Setting of contrast of LCD screen
- Date and time setting
- Language setting
- Operation mode
- Touch panel calibration
- User options
- Way of operation
- Information about the unit
- Service functions

3.2.1 Password Setting

Changes password required to operate the unit after power-up. The units as standard come with this function disabled.

If the unit includes a laser generator - **BTL-5000 Laser, BTL-58xx L, BTL-58xx xL**, you cannot disable the password code (in compliance with the applicable standards). In this case a four-digit code is factory-set to **0000**.

3.2.2 Audio Tones Setting

Sets audio signaling of buttons and provides warnings of various operational conditions (start of therapy, stop or pause of therapy). All audio tones can be switched off or modified as required.

Units with laser generator - **BTL-5000 Laser, BTL-58xx L, BTL-58xx xL** - cannot have the audio tone of the running therapy switched off (in compliance with the applicable standards).

Volume can be set in the **User options** menu (see Chapter **3.2.10 User Options**).

3.2.3 Setting of Colours (for colour variant only)

The user can set colours of all elements displayed on the screen: select one of 10 available preset colour schemes or, if not satisfied with any of them, create and save custom colour schemes. In the custom colour scheme the user successively selects individual elements.

3.2.4 LCD Screen Saver and Auto Power Off

Selects the design of screen saver and sets the time for activation of the screen saver. Sets auto power off feature for switch-off of the LCD screen and for switch-off of the equipment.

3.2.5 Setting of Contrast of LCD Screen

Sets the optimum clarity of the screen. Use the **select (14)** knob.

The contrast of the screen depends on various factors, such as temperature.

For fast and direct screen contrast setting, use the **select (14)** knob while simultaneously holding the **enter (15)** and **esc (16)** buttons.

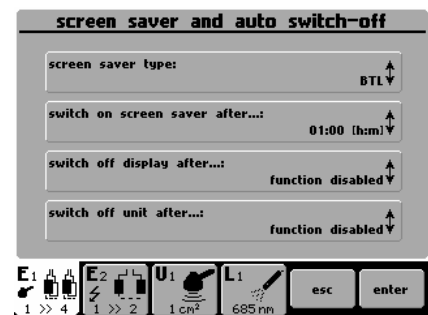

3.2.6 Date and Time Setting

Sets the date and time.

3.2.7 Language Setting

Selects the language of the text displays presented on the screen. Factory pre-set is **English**.

3.2.8 Operation Mode

Selects one of the three modes, see Chapter 2.5.6 Therapy Parameters Screen – Ergonomic, Standard and Expert Mode.

Factory-preset is **ergonomic mode**.

3.2.9 Touch Panel Calibration

If the buttons on the touch screen do not react when pressed, the touch screen needs calibration. Calibration values are displayed on the screen and the soft touch stylus is used to make adjustments to the sensitivity of the buttons.

Press **esc** to stop calibration. To verify touch screen adjustments, use the '**touch panel function test**' function.

Press '**ESC**' to stop calibration.

To verify touch screen adjustments, use the "**TOUCH PANEL FUNCTION TEST**".

3.2.10 User Options

Here, you can set:

- direction of cursor movement when using the **select (14)** control
- listing of therapies and some other menu options (in ascending or descending alphabetical order)
- location of the tab bar (up / down)
- speaker volume

3.2.11 Way of Operation

3.2.11.1 New Operation Mode

Use this option for the first series BTL-5000 units manufactured in 2001 and early in the year 2002. These units have the knobs (17) and (18) marked as **time (17)** and **start / stop (18)**. For these units, select the option **new operation mode = no** (after the new version of firmware is loaded).

New units are factory pre-set to new operation mode (**new operation mode = yes**).

3.2.11.2 End of Therapy – Setting Zero Intensity and Time Values

After the end of therapy, you can have displayed either zero values of intensity and time or the intensity and time values of the last performed therapy.

3.2.12 Network Setting

This option is applicable only if the device is connected in network. Here it is possible to set the name by which the device will report in the network. It is possible to set if the device shall automatically login in the network after startup or if it will be logged in only after pressing a button. This item also provides test of functionality of the network and information about all devices connected in the network.

For operation of the devices in the network it is necessary to have purchased the software package for the master computer; in addition, the network must be professionally installed by an authorized distributor's representative. Detailed information about network interconnection and control is included in the software package.

3.2.13 Information about the Unit

Displays info about the unit (serial number, firmware version, etc.). It also contains the information till when the device will work – so called "device validity". If the functioning of the device is temporary, this item contains the information until which date the device will be fully functional.

3.2.14 Service Functions

3.2.14.1 Repair of Files

Checks the file system in the unit and repairs possible errors -- deletes empty files, etc. Recommended for use in case of lack of memory, if the unit rejects to save data, or if you think that some data have been lost.

3.2.14.2 File System Formatting

Clears all data and programs created by the user. You may select this function if the “**repair of files**” function did not help.

3.2.14.3 Delete Installed Accessories

Deletes all installed accessories. Use only in case of improper installation – corrupted accessory image on the channel tab, connected accessories are not detected (the “?” symbol is displayed), etc.

3.2.14.4 Default Setting without Losing User Data

All factory settings are restored. User data, such as patients, therapies, etc. are preserved.

3.2.14.5 Restart of All Generators

This function switches all generators in the device off and on, to get them into the initial status such as at starting of the device. Therapy possibly running on a generator (tab) is stopped. This function should be used only in cases when e.g. by electromagnetic interference a generator switches off and its activity cannot be restored without switching the whole device on and off. This function enables to initialize generators without the need of restarting the whole unit.

3.2.14.6 Information of Free Space for User Data

The bottom part of the screen displays the current free space in the memory that can be used for user data. User data are for example patients, saved user diagnoses, I/t curves, etc.

The user can use the memory marked "E:"; the memory marked "S:" is intended for internal use.

3.2.15 Special Settings

Vary for each generator. See your User's Guide for details.

4 USER OPTIONS VIA THE “USER” BUTTON

Pressing the **user (13)** button opens a screen allowing access to special features of the unit, as well as to data saved by the user. The following items can be selected:

- patients
- user sequences
- user diagnoses / programs
- recent therapies
- detection of motor point*
- rheobasis – chronaxie*
- accommodation coefficient*
- I/t curve*

* Available only with electrical stimulator equipped with electrodiagnostics (optional).

4.1 PATIENTS

Insert, edit, or delete a patient’s name. The patient can be assigned a particular therapy. If your stimulator is equipped with electrodiagnostics, you can assign to the patient a measured I/t curve, accommodation coefficient, and rheobasis and chronaxie values.

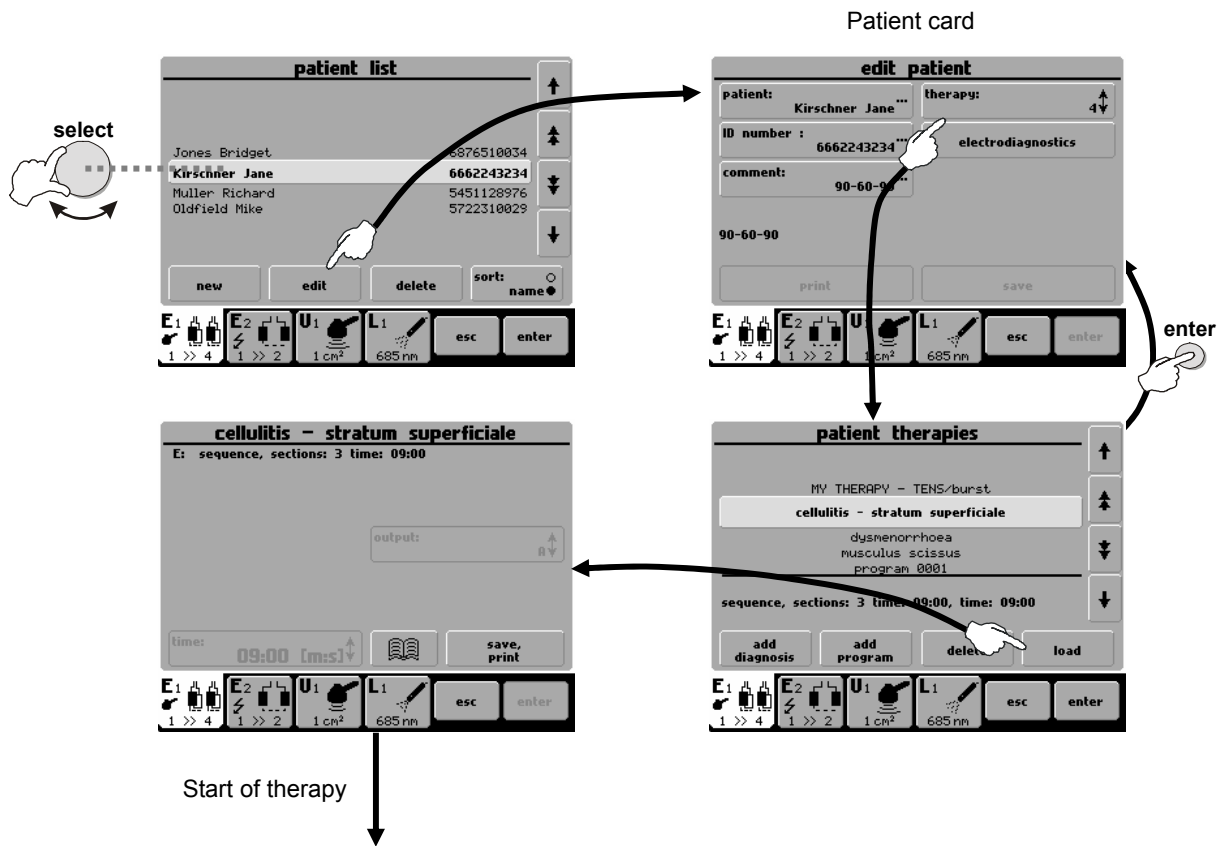

For details on electrodiagnostics, refer to the **User Guide for Electrotherapy**.

4.2 USER SEQUENCES

Serves to work with the list of self-designed sequences of therapy programs. The selected sequence can be run, edited, and deleted from this menu.

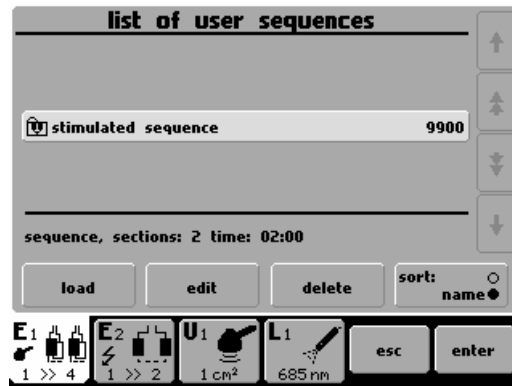

4.2.1 Creating New Sequence

Limitation of choice of currents in one sequence when there is no pause set between the sections:

If the option **pause between sections** is set, the unit stops generation after each current and the intensity of the next current has to be set manually. In this case, there is no limitation and the user can select and combine any current in one sequence. We suggest to set this option for electrotherapy sequences.

If the pause between sections is not set, the unit generates the same intensity for all currents. Be careful when setting sequences. Each current is felt differently by the patient. Whereas in case of TENS the patient tolerates intensity of about 100 mA, the maximum tolerated intensity in case of DD currents is 10 times lower. Combine in one sequence only currents that are perceived by the patient in a similar way – such as currents with the same pulse length and with maximum difference in frequency 1:10. Monophasic, symmetric and alternating currents should not be mutually combined.

The following combinations are recommended if the pause between sections is not set:

- diadynamic currents
- monophasic pulses of the same length with DC component (differing in frequency or modulation)
- symmetric pulses of the same length with zero DC component (differing in frequency or modulation)
- alternating pulses of the same length with zero DC component (differing in frequency or modulation)
- mid-frequency bipolar currents (differing in frequency or modulation)
- interferences
- TENS (differing in frequency or modulation)
- ultrasound therapies
- laser therapies

Open the therapy parameters screen. In the manual mode select **therapy / sequence** (or **ultrasound sequence** or **laser sequence**). Creation of a new sequence is displayed in the following diagram:

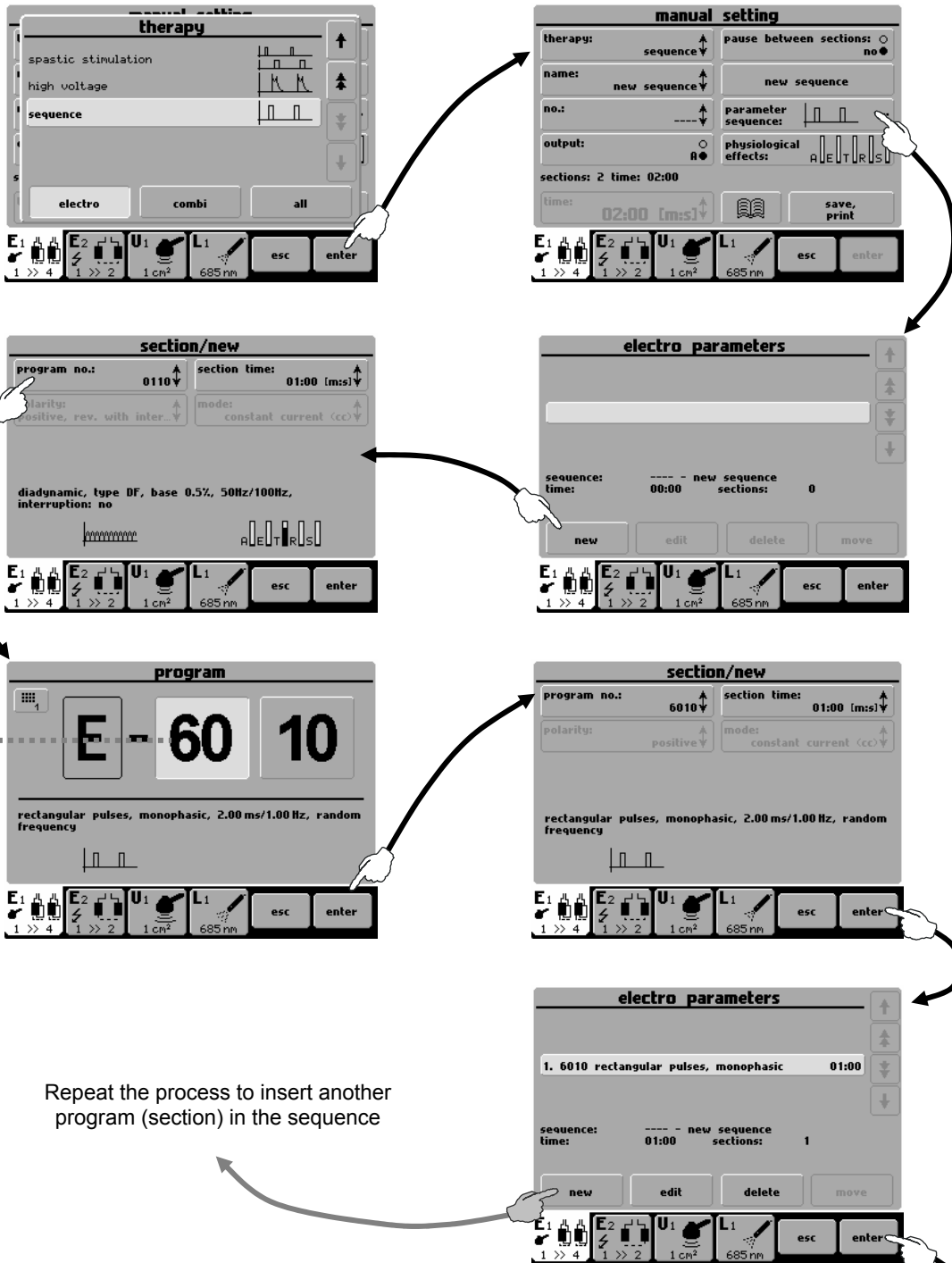

Repeat the process to insert another program (section) in the sequence

Pressing **enter** will confirm the sequence and exit to the therapy parameters screen. Here you can press the **print/save** button to select the way of saving and parameters and to save the sequence (see 4.2.2 Saving New Sequence).

4.2.1.1 Parameters of Sections in Sequence

A sequence consists of a few currents/programs that are called sections. Parameters of sections must be set when creating a sequence.

Each program includes basic current parameters such as frequency, pulse length, modulation etc.. For more information, please refer to Chapter 2.9.1 **Save Therapy**. Set all data in the manual setting screen and save them as a user-designed program (diagnosis). Insert the program in the sequence. Set the length of time of the section when inserting the program in the sequence (except laser, where the time of section depends on the currently connected laser probe). Obviously, the factory-preset programs can also be inserted in the sequences. In the section only the polarity can be set (for electrotherapy sequence). The other parameters must be specified and saved in the inserted program.

Example: you want to create a sequence of diadynamic DF current (without base, positive polarity, CC mode, time of stimulation: 1 minute) and CP-ISO current (base 10%, reversal of polarity in the middle of the set time, CC mode, 10 minutes). Press **man** to select the manual mode, set diadynamic currents, DF type, without base, positive polarity, CC mode. Save this setting as (for example) program E-8001. Then set the parameters of the CP-ISO current: base 10%, positive, reversal, CC mode, and save it as (for example) program E-8002. Select therapy and press **new sequence** then press **new**, set the program number **8001**, set the time of section **1:00**, positive polarity, and press **enter**. Then add the second section in the same way – **new**, program number **8002**, time of section **10:00**, positive polarity with reversal, and press **enter**. Then press **enter** again to return to the manual settings screen, press **print/save** and save the sequence (for example as number 9501). The cv/cc mode is set globally for the whole sequence before starting it.

4.2.2 Saving New Sequence

Sequence created according to 4.2.1 **Creating New Sequence** can be saved as follows:

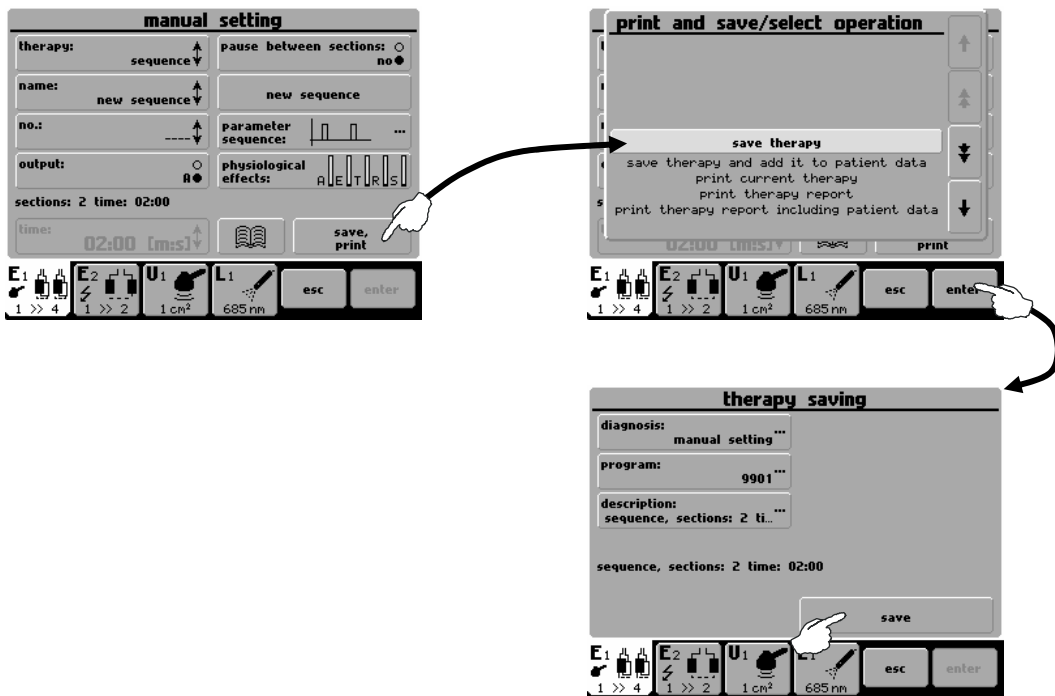

User-made sequences are saved under numbers 9500 - 9999. They can be found in the list of programs, in the list of diagnoses or in the list of sequences.

4.3 USER DIAGNOSES / PROGRAMS

Use this feature to run user designed therapies and edit and delete their parameters, names and therapy comments. It is very similar to the creation of a new diagnosis / program – see **2.9 Therapy Printing and Saving**. On each channel tab, you can see only those therapies that were created on this tab. An icon before the name of the therapy will tell you which type of generator the therapy has been designed for.



4.4 LIST OF RECENT THERAPIES

Allows the user to select a recent therapy on the selected tab, run it again after pressing the **load** button or view its parameters.



5 ACCESSORIES

The equipment is not designed for use in connection with other medical devices except those stated in this manual. Following is a list of accessories that can be supplied with the units, both standard and optional. For detailed information on individual accessories see the enclosed leaflet and/or the user's manual.

5.1 ACCESSORIES COMMON FOR ALL UNITS

mains cable
spare fuse
touch-pen
user's manual
markers for output cables
cart

5.2 ACCESSORIES FOR ELECTROTHERAPY

user's guide for electrotherapy
patient cable BTL-236-1
patient cable BTL-236-2
flat rubber electrodes 4 x 5cm²
flat rubber electrodes 5 x 7cm²
flat rubber electrodes 5 x 12cm²
sponge covers 4 x 5cm²
sponge covers 5 x 7cm²
sponge covers 5 x 12cm²
set of fixation belts
point electrode P5600.013
 ball point attachment – diameter 2mm P5600.014
 ball point attachment – diameter 6mm P5600.015
 HVT attachment – P5600.017
self-adhesive electrodes
vaginal electrode P5600.010
rectal electrode P5600.011
interface cable between BTL-5000 and BTL vac, type PVAC.056

5.3 ACCESSORIES FOR ULTRASOUND THERAPY

user's guide for ultrasound therapy
holder for ultrasound head
1cm² ultrasound head BTL-237-1-13 for 1 and 3MHz, ERA 0.7 cm²
4cm² ultrasound head BTL-237-4-13 for 1 and 3MHz, ERA 3.24 cm²
ultrasound gel 235ml, 5l, 10l
interface cable between BTL-56xx Puls and BTL-57xx Sono, type PVAC.056

5.4 ACCESSORIES FOR LASER THERAPY

user's guide for laser therapy
laser probes - red BTL-448
laser probes – infrared BTL-448
laser clusters - red BTL-445
laser clusters - infrared BTL-445
laser clusters - combined (red and infrared) BTL-445
optical attachments for laser probes
attachment for laser probe
warning labels
safety goggles OPTE BS 2, L3, 630 – 1350nm

6 MAINTENANCE AND SAFETY INSTRUCTIONS

All maintenance and repairs must be carried out by authorized personnel only. The manufacturer bears no responsibility for the results of maintenance or repairs by unauthorized persons.

Safe operation of any item of medical equipment requires close attention to detail. Please check the following on a regular basis:

Power cord and plug: Check for frays and kinks. Ensure that the insulation is not damaged in any way.

Ultrasound head surface: Gel should always be thoroughly cleaned from the surface of the head. Always maintain this surface in as clean a condition as possible. Do not use any abrasive products for cleaning this surface as they could damage this delicate accessory.

Wires, cables and electrodes: Check for frays, cuts or tears in the insulation. Always route electrical cords and cables away from user or patient foot traffic areas where they could increase the chance of a tripping-related accident.

Check the unit before each use to determine that all controls function normally.

Calibration of heads and probes/clusters must be done by authorized personnel.

Cleaning

To keep the device clean, do not store or use it in dusty environment and do not spill any liquid on the surface. To clean, turn the equipment off and unplug the power supply. Clean the unit with a damp cloth. Do not use abrasive materials. Do not use agents containing alcohol, ammonia, benzene, thinners. We recommend that you clean the accessories that come into contact with the patient after each treatment. Use appropriate agents. No part of the equipment needs to be aseptic or sterilized.

Laser probes/clusters: Keep the lens clean. After each application wipe the head of the probe by a cotton cloth (divergent probes). Unscrew the head, wipe the lens and blow compressed air through the head (convergent probes). In laser clusters wipe the laser aperture with a cotton cloth so as to keep the protective glass clean.

Laser optical attachments: Can be sterilized for 10 minutes at the temperature of 120°C.

Fuse replacement

The fuse is located in the round black box (24) on the rear panel. Make sure the mains switch (21) is in the "0" position. Unplug the power cord from the mains and from the equipment. Turn the segment of the fuse case to the left by a fitting screwdriver or coin in the slot. Remove the fuse. Insert a new fuse of the same rating and turn the box to the right.

Switching mains voltage

Before first connection of the equipment to the mains it is necessary to check if the mains voltage switch (27) is in the position corresponding to the correct voltage configuration, either in the "230V" or "115V" position. To change the voltage, make sure that the mains switch (21) is in the "0" position. Unplug the mains cable from the mains as well as from the equipment. Turn the segment of the switch by a fitting screwdriver or coin in the slot in the desired direction.

Transport and Storage

We recommend keeping the original packaging of this equipment to ensure its maximum protection during transportation. Unplug the mains cable and the accessories cables. The equipment must be stored or transported as defined in Section 7 **Technical parameters**.

6.1 SAFETY

ATTENTION!



The consumed current or voltage of the connectors marked by this label can exceed the safety values.

ATTENTION!

This system has no user-serviceable parts or assemblies. Do not remove the instrument covers under any circumstances. Call your distributor for advice about any malfunction.

The device is equipped with a protection system that prevents connection of other accessories than supplied from the manufacturer.



General safety precautions:

- Read this manual thoroughly before operating the equipment.
- The device should only be used under the continued supervision of a physician or licensed practitioner.
- All staff should be instructed by the manufacturer or the distributor in the operation, maintenance and checking of the equipment and of all safety features and protocols.
- Make sure the electrical network in your facility is in compliance with valid standards.
- Check if the voltage switch located at the bottom of the equipment is switched to the correct voltage for your facility.
- Do not use this equipment in the presence of explosive gases and flammable anaesthetics.
- Using this equipment in close proximity to other equipment may cause electromagnetic interference.
- Avoid the use of liquids in the immediate vicinity of this equipment since any liquid spilled onto the case may cause serious damage to internal components.
- Inspect the equipment thoroughly before each use (loose cables, broken insulation of cables, display functions, buttons, etc.).
- If the equipment shows any deviations from a normal operating situations, discontinue use and report the fault to authorized service personnel.
- Do not dismantle the equipment under any circumstances. Removal of protective covers implies the danger of electrical injury. Replacement of the lithium accumulator may only be done by authorized service personnel.
- Make sure that all materials and parts that come to direct contact with patient's skin comply with your national health standards.
- The connectors for accessories as well as the other connectors must not be used for connection of anything else than they are designed for, otherwise there is a danger of electric shock injury and serious damage to the equipment!
- The equipment does not use or produce any toxic substances during its operation, storage or transport.
- Exercise care when bringing the equipment from a cold environment to warm room. Do not plug it in the mains for at least 1 hour. Never expose this equipment to very warm or very cold climatic conditions.
- Check all pre-set parameters before commencing therapy.
- Never apply therapy on damaged skin!
- To terminate the therapy, press the **start / stop** button (18), not the mains switch. The time interval between switching the mains switch off and on must be at least 3 seconds.
- Discard the equipment only after the lithium accumulator was removed. The equipment does not contain any toxic materials that would harm the environment.
- Use the equipment and the accessories only in accordance with the manual.
- Use recommended protective devices when operating the equipment.
- Keep the equipment out of the reach of children.
- Always have the unit repaired by authorized service personnel.
- Always follow your local and national electrical, safety and healthy standards when using this equipment. Call your distributor for advice.
- The device does not have any user-servicing parts. Do not remove any covers. Always have the unit repaired by BTL Service Department.

**Safety precautions for electrotherapy:**

- When applying DC currents (the **polarity** button is active) pay extra attention to the set intensity and time of application. Improper values can cause skin burning.
- The maximum safety effective value of current density on the electrodes is 2 mA/cm² (according to IEC 601-2-10) and can be extended only when electrodes smaller than 70 cm² are used. In this case pay extra attention to application of currents! Improper values can cause skin burning.
- Application of electrodes in the area of the thorax may increase the risk of cardiac fibrillation.
- Simultaneous connection of the patient to a high-frequency surgical device may cause burning in the place of the electrodes and possible damage to the electrotherapy device.
- Simultaneous connection of the patient to an ECG monitor or ECG alarm system can lead to temporary improper functioning of the systems.
- Operation of the equipment close to (within 1m) a short-wave or micro-wave therapeutic device may cause instability of the equipment's output..
- All supplied electrodes can be used for maximum intensities of currents and voltage as enabled by the equipment

**Safety precautions for ultrasound:**

- Always take great care when handling the ultrasound head since it contains delicate components that may be damaged by dropping or impact with furniture or the hard surfaces. Do not bend the mains cable.
- **During therapy hold the sound head so that you do not touch its metallic parts.**
- For therapy use only the BTL ultrasound gel; the head is not tested for other gels or oils and use of them could damage the head. If you still want to use other gels, we recommend them to be only water-based gels.

**Safety precautions for laser:**

- Mark the laser workplace by respective warning labels as required by law. Activate the door sensor function.
- Equip the laser workplace by working rules in accordance with your national standards.
- The therapy duration must not exceed 15 min. in case the laser probe/cluster of 200mW output and higher is used, and provided the laser output is set to over 150mW.
- The use of product out of accord with the recommended settings can cause dangerous exposition to radiation.
- The equipment works with the 3B class laser beam. Prevent the laser beam from hitting eyes, thyroid and other endocrine glands, head, etc. Both the therapist and the patient must wear protective glasses during therapy. Follow all instructions in this manual. Incorrect use of the equipment may cause dangerous radiation and damage to the eyes!
- Do not disconnect the probe/cluster from the equipment and do not switch the equipment off during radiation!
- **Protect laser probes/clusters from shocks! The probe/cluster is not water-proof.**
- **Protect yourself and people around from direct hit by the laser beam.**

6.2 USEFUL ADDRESSES

The product is manufactured in accordance with the EU Medical Devices Directive by :

BTL Industries Ltd.

Suite 401 Albany House
324-326 Regents Street
London, W1B 3BL United Kingdom
E-mail: sales@btl.net
<http://www.btl.net>

For service, please contact service department at service@btl.net.

6.3 WARRANTY

The Manufacturer of this product warrants the product to be free from defects in workmanship and material for a period of twelve months after the date of shipment from the factory. This warranty excludes any disposable items and accessories, including, but not limited to cables or leads, power cords and electrodes. The manufacturer agrees to correct such defects without charge, or at its option to replace the item with a comparable model. To register and be eligible for warranty service, you must send or fax the fully completed warranty registration form within 30 days of installation. All costs of shipment are the responsibility of the purchaser. Damage to any part such as by accident or misuse or improper installation or by use of any accessories or abrasive material not produced by the Manufacturer is not covered by this warranty. Because of varying climatic conditions, this warranty does not cover any changes in finish, including rusting, pitting, corrosion, tarnishing or peeling. Servicing performed by unauthorized persons render this warranty invalid. There is no other express warranty. The Manufacturer hereby disclaims any and all warranties, including but not limited to, those of merchantability and fitness for a particular purpose to the extent permitted by law. The duration of any implied warranty which cannot be disclaimed is limited to the time period as specified in the express warranty. The Manufacturer shall not be liable for incidental, consequential, or special damages arising out of, or in connection with product use or performance except as may be otherwise accorded by law.

This warranty may differ from the warranty terms and conditions provided by your supplier and by applicable laws in your country.

6.4 CONTRAINDICATIONS

The list of contraindications gives the cases when the manufacturer does not recommend to apply the selected therapy. If a specialised medical workplace decides to apply the therapy in spite of it, they bear all the responsibility for this action.

6.4.1 Contraindications - Electrotherapy

- Active tuberculosis
- Allergy to solutions used for dampening of electrode cover sponges
- Applications in the areas of heart and eyes
- Groundless stimulation - "placebo effect"
- Pacemaker
- Cardiovascular diseases
- Cochlear implants
- Metal implants and malignancies in the current path
- Skin defects and skin inflammations
- Bleeding conditions
- Menstruation
- Tumorous diseases
- Sensitivity disorders (relative KI) in the area of electrode placement
- Psychopathological syndromes and organic psychosyndromes
- Multiple sclerosis
- Pregnancy
- Inflammations of veins and lymphatic paths

6.4.2 Contraindications - Ultrasound

- Active tuberculosis
- Allergies to used ultrasound gels
- Applications on peripheral nerves (located on the bone, close to skin surface)
- Applications on glands with inner secretion
- Applications on areas around eyes, brain, spinal cord
- Blood diseases
- Epiphyses of growing bones
- Gonads
- Pregnancy
- Pacemaker
- Cardiovascular diseases
- Cochlear implants
- Metal implants
- Skin defects and skin inflammations
- Bleeding conditions
- Menstruation
- Tumorous diseases
- Blood circulation deficiency
- St. p. laminectomii

6.4.3 Contraindications - Laser therapy

- Applications in the area of eyes – possibility of direct eye irradiation and retina damage
- Menstruation
- Tumorous diseases
- Irradiation of malignancies and potentially precancerous growths
- Irradiation of patients with cochlear implants
- Irradiation of glands with inner secretion
- Patients with febrile conditions
- Pulse modes (both red and infrared beam) are not used for patients with anamnesis of epilepsy
- Pregnancy

7 TECHNICAL PARAMETERS

| | |
|--|--|
| Identification of the unit | BTL-5000 Series – physiotherapy unit For unit configuration see Chapter 8 Units Configurations |
| Operating conditions | |
| Ambient temperature | + 10 °C to + 40 °C |
| Relative humidity | 30 % to 75 % |
| Atmospheric pressure | 700 hPa to 1060 hPa |
| Position | vertical – on legs |
| Type of operation | continuous |
| Transport and storage conditions | |
| Ambient temperature | - 10 °C - + 55 °C |
| Relative humidity | 25 % - 85 % |
| Atmospheric pressure | 650 hPa - 1100 hPa |
| Position | any |
| Max. storage time | max. 1 year |
| Additional conditions | transport only in the supplied packing |
| Power supply | |
| Input max. | 80 VA |
| Voltage | ~ 99 V - 126 V (115 V nominal), alternately ~ 198 V to 252 V (230 V nominal), alternately |
| Frequency | 50 Hz - 60 Hz |
| Equipment protection class | II (according to IEC 536) |
| External exchangeable fuse | T1.6A / 250V, tube fuse 5 x 20 mm, according to IEC 127-2 |
| Mains switch according to IEC 601-1 | on the rear side of the equipment, positions 0 and I |
| Power switch | on the front panel, labelled on off |
| Internal chemical sources | |
| Type of batteries | lithium CR2032 (replacement by BTL Service Department) |
| Design | |
| Weight – device only | max. 5 kg |
| Weight – including packing and accessories | max. 8 kg |
| Dimensions (l x h x w) | 230 x 390 x 260 mm ³ , (9.1“ x 15.4“ x 10.2“) |
| Dimensions – when packed (l x h x w) | 480 x 500 x 400 mm ³ , (18.9“ x 19.7“ x 15.8“) |
| Covering grade according to EN 60 529 | IP 20 |
| Display unit | |
| Display | LCD b/w 320x240 (¼ VGA), diag. 14.5 cm (5.7“) LCD colour 640x480 (VGA), diag. 19 cm (7.5“) |
| Classification | |
| Applied part type | BF |
| Class according to MDD 93/42/EEC | IIb |
| Time of therapy | |
| For electro and laser therapies | 0 to 100 minutes |
| For ultrasound therapies | 0 to 30 minutes |
| Step of setting | 1 second |
| Accuracy of therapy time | ± 2 % from the pre-set value |
| Accuracy of timer | 5 second per day |

7.1 BASIC PARAMETERS OF ELECTROTHERAPY GENERATOR

Adjustable values

| | |
|--------------------------------|---|
| Output current* | max. 140 mA (maximum instantaneous value) |
| Output current - HVT* | max. 4 A (maximum instantaneous value) |
| Output current - microcurrents | max. 999 µA (maximum instantaneous value) |
| Output voltage | max. 130 V (maximum instantaneous value) |

| | |
|---|--|
| Output voltage - HVT | max. 390 V (maximum instantaneous value) |
| *maximum value for some currents is limited according to IEC 601-2-10 | |
| Tolerance of output amplitude | ± 10 % for 5 mA (5 V, 5 µA) and higher; otherwise ± 30 % |
| | ± 10 % for 35 V and higher; otherwise ± 30 % (for HVT) |
| Tolerance of time parameters of current | standard ± 5 %; maximum ± 15 % |
| | standard ± 20 % for modulation of HVT from 5 s; otherwise ± 30 % |
| Nominal load impedance | 500 Ω |
| Internal output resistance in CV mode | 96 Ω ± 10 % |
| Internal output resistance in CC mode | 47 kΩ ± 10 % |
| Output capacity | standard 150 pF |
| Output polarity – can be selected | positive / negative / with reversal in the middle of the therapy |
| Positive polarity | red banana plug = + = anode; black banana plug = - = cathode |
| Negative polarity | red banana plug = - = cathode; black banana plug = + = anode |

7.2 BASIC PARAMETERS OF ULTRASOUND GENERATOR

Adjustable values

| | |
|-----------------------|---|
| Effective intensity | |
| Continuous operation | 0.1 to 2 W/cm ² ± 20 % for output intensity higher than 0.2W/cm ² |
| Pulse operation | 0.1 to 3 W/cm ² ± 20 % for output intensity higher than 0.2W/cm ² |
| Working frequency | 1 MHz ± 5 % and 3.2 MHz ± 5 % |
| Modulation frequency | 10 to 150 Hz ± 5 % |
| Duty factor | 6 to 100 % ± 5 % of the set value |
| Duty factor – default | 6.25 % (1:16); 12.5 % (1:8); 25 % (1:4); 50 % (1:2), 100% (1:1) ± 5 % of the set value |
| Maximum output power | 12W |

Parameters of pulses

| Duty factor | Frequency 10 Hz period 100 ms | | Frequency 50 Hz period 20 ms | | Frequency 100Hz period 10 ms | | Frequency 150 Hz period 6.67 ms | |
|-------------|----------------------------------|--------------|---------------------------------|--------------|---------------------------------|--------------|------------------------------------|--------------|
| | Pulse length | Pause length | Pulse length | Pause length | Pulse length | Pause length | Pulse length | Pause length |
| 50 % | 50 ms | 50 ms | 10 ms | 10 ms | 5 ms | 5 ms | 3.33 ms | 3.33 ms |
| 25% | 25 ms | 75 ms | 5 ms | 15 ms | 2.5 ms | 7.5 ms | 1.67 ms | 5 ms |
| 10% | 10 ms | 90 ms | 2 ms | 18 ms | 1 ms | 9 ms | 0.67 ms | 6 ms |
| 6% | 6 ms | 94 ms | 1.2 ms | 18.8 ms | 0.6 ms | 9.4 ms | 0.40 ms | 6.27 ms |

Steps of adjustable values

| | |
|----------------------|-----------------------|
| Intensity | 0.1 W/cm ² |
| Modulation frequency | 10 Hz |
| Duty factor | 1% |

7.3 BASIC PARAMETERS OF LASER GENERATOR

| | |
|---|---|
| Indication of emission of laser radiation | green pilot light on the probe, supplementary lighting of the probe/cluster, sound |
| Indication of readiness for emission | on the screen |
| Indication of unreadiness for emission | on the screen |
| Additional safety means | - warning labels on the device case and on the probe/cluster - warning label for the entrance door of the workplace - connector of the remote control |

Connector of the remote control (door switch)

| | |
|---------------|--|
| input voltage | AC / DC 5 V to 35 V (external power supply) / automatic polarity recognition |
| input current | max. 10mA |
| active level | settable positive / negative logic |

Adjustable values

| | |
|-------------------------|--|
| Frequency*** | 0 – 5000 Hz, (0 – 10000 Hz for C variant) with laser probe BTL-448 0 – 500 Hz with laser cluster BTL-445 |
| accuracy of frequency | ± 3 % of the stated value |
| Dose* | 0.1 – 100.0 J/cm ² |
| accuracy of dose | ±20% (according to IEC 60601-2-22) |
| Area* | 0.1 – 100.0 cm ² |
| accuracy of area | see BNR |
| Output* | 5.0 – 500 mW (depending on the connected laser probe) 20 – 1800 mW (depending on the connected laser cluster) |
| accuracy of output | ±20% (according to IEC 60601-2-22) |
| Duty factor** | 10 – 90 % |
| accuracy of duty factor | ±1% of the range of DF |

*) The stated values are maximum. The actual values depend on the type of the connected laser generator and on the ordered configuration of the device

**) Can be set only in the pulsed mode, in the continuous it is always 100%

***) Zero frequency means continuous operation

7.4 TECHNICAL PARAMETERS OF ULTRASOUND HEADS**BTL-237-1-13 – small head**

| | |
|---------------------------------------|---------------------------|
| Effective radiation area (ERA) | |
| ERA (EN 61689) | 0.7 cm ² ± 20% |
| ERA (21 CFR 1050) | 0.9 cm ² ± 20% |
| Maximum effective intensity | 3 W/cm ² ± 20% |
| Maximum effective acoustic power | 2.1 W ± 20% |
| Radiation frequency | 1 MHz and 3.2 MHz ± 5% |
| Type of beam | collimated |
| BNR | < 8 |
| Covering grade according to EN 60 529 | IP 67 |

BTL-237-4-13 – large head

| | |
|---------------------------------------|---------------------------|
| Effective radiation area (ERA) | |
| ERA (EN 61689) | 3.2 cm ² ± 20% |
| ERA (21 CFR 1050) | 4.4 cm ² ± 20% |
| Maximum effective intensity | 3 W/cm ² ± 20% |
| Maximum effective acoustic power | 9.6 W ± 20% |
| Radiation frequency | 1 MHz and 3.2 MHz ± 5% |
| Type of beam | collimated |
| BNR | < 8 |
| Covering grade according to EN 60 529 | IP 67 |

7.5 TECHNICAL PARAMETERS OF LASER PROBES**Laser probes with red (visible) radiation:**

| Type: | BTL-448-03RD | BTL-448-03RC | BTL-448-05RD | BTL-448-05RC |
|---------------|---------------------|-----------------------|---------------------|-----------------------|
| Output power: | 30 mW ± 20 % | 30 mW ± 20 % | 50 mW ± 20 % | 50 mW ± 20 % |
| Wavelength: | 685 nm | 685 nm | 685 nm | 685 nm |
| Class*: | 3B | 3B | 3B | 3B |
| Beam: | divergent | collimated | divergent | collimated |
| Aperture: | Ø 2 mm | Ø 4.4 mm | Ø 2 mm | Ø 4.4 mm |
| BNR: | 0.28 rad ± 0.05 rad | 0.015 rad ± 0.005 rad | 0.28 rad ± 0.05 rad | 0.015 rad ± 0.005 rad |
| NOHD**: | 0.2 m | 2.3 m | 0.2 m | 3.4 m |

Laser probes with infrared (invisible) radiation:

| Type: | BTL-448-05IC | BTL-448-10IC | BTL-448-20IC | BTL-448-30IC |
|---------------|-----------------------|-----------------------|-----------------------|-----------------------|
| Output power: | 50 mW ± 20 % | 100 mW ± 20 % | 200 mW ± 20 % | 300 mW ± 20 % |
| Wavelength: | 830 nm | 830 nm | 830 nm | 830 nm |
| Class*: | 3B | 3B | 3B | 3B |
| Beam: | collimated | collimated | collimated | collimated |
| Aperture: | Ø 4.4 mm | Ø 4.4 mm | Ø 4.4 mm | Ø 4.4 mm |
| BNR: | 0.015 rad ± 0.005 rad | 0.015 rad ± 0.005 rad | 0.015 rad ± 0.005 rad | 0.015 rad ± 0.005 rad |
| NOHD**: | 8.5 m | 12.1 m | 12.5 m | 16.6 m |

| Type: | BTL-448-40IC |
|---------------|-----------------------|
| Output power: | 400 mW ± 20 % |
| Wavelength: | 830 nm |
| Class*: | 3B |
| Beam: | collimated |
| Aperture: | Ø 4.4 mm |
| BNR: | 0.015 rad ± 0.005 rad |
| NOHD**: | 19.2 m |

*Laser class is classified according to IEC 60601-2-22:1995 and IEC 60825-1:1993/A2:2001.

**NOHD – nominal ocular hazard distance (nominal distance from the laser aperture in which the eye damage by laser beam should not happen)

7.6 TECHNICAL PARAMETERS OF LASER CLUSTERS**Laser clusters with red (visible) radiation:**

| Type: | 445-C25R02 |
|---------------|-------------------------------|
| Output power: | 200 mW ± 20 % (4x 50 mW) |
| Wavelength: | 4x 685 nm |
| Class*: | 3B |
| Beam: | 4x divergent |
| Aperture: | 4x Ø 1.5 mm |
| Active area: | Ø 56 mm (25 cm ²) |
| BNR: | 4x 0.35 rad ± 0.05 rad |
| NOHD**: | 0.2 m |

Laser clusters with infrared (invisible) radiation:

| Type: | 445-C25I08 | 445-C25I16 |
|---------------|-------------------------------|-------------------------------|
| Output power: | 800 mW ± 20 % (4x 200 mW) | 1600 mW ± 20 % (4x 400 mW) |
| Wavelength: | 4x 830 nm | 4x 830 nm |
| Class*: | 3B | 3B |
| Beam: | 4x divergent | 4x divergent |
| Aperture: | 4x Ø 3.5 mm | 4x Ø 3.5 mm |
| Active area: | Ø 56 mm (25 cm ²) | Ø 56 mm (25 cm ²) |
| BNR: | 4x 0.52 rad ± 0.17 rad | 4x 0.52 rad ± 0.17 rad |
| NOHD**: | 8.5 m | 12.1 m |

Combined laser clusters with red and infrared radiation:

| Type: | 445-C25RI10 | 445-C25RI18 |
|---------------|--|--|
| Output power: | red: 200 mW ± 20 % (4x 50 mW) infrared: 800 mW ± 20 % (4x 200 mW) | red: 200 mW ± 20 % (4x 50 mW) infrared: 800 mW ± 20 % (4x 200 mW) |
| Wavelength: | red: 4x 685 nm infrared: 4x 830 nm | red: 4x 685 nm infrared: 4x 830 nm |
| Class*: | 3B | 3B |
| Beam: | 8x divergent | 8x divergent |
| Aperture: | red: 4x Ø 1.5 mm infrared: 4x Ø 3.5 mm | red: 4x Ø 1.5 mm infrared: 4x Ø 3.5 mm |

| | | |
|---------------------|---|---|
| Active area: | \varnothing 56 mm (25 cm ²) | \varnothing 56 mm (25 cm ²) |
| BNR: | red: 4x 0.35 rad \pm 0.05 rad infrared: 4x 0.52 rad \pm 0.17 rad | red: 4x 0.35 rad \pm 0.05 rad infrared: 4x 0.52 rad \pm 0.17 rad |
| NOHD**: | 8.5 m | 12.1 m |

*Laser class is classified according to IEC 60601-2-22:1995 and IEC 60825-1:1993/A2:2001.

**NOHD – nominal ocular hazard distance (nominal distance from the laser aperture in which the eye damage by laser beam should not happen) .

7.7 APPLICABLE STANDARDS

| Name | IEC, EN, ISO, MDD |
|--|-------------------|
| Medical electrical equipment. Part 1: General requirements for safety | IEC 601-1 |
| Amendments to IEC 601-1 | A2, A11, A12 |
| Medical electrical equipment Part 1: General requirements for safety 1.Collateral standard: Safety requirements for medical electrical systems | IEC 60601-1-1 |
| Medical electrical equipment Part 1: General requirements for safety 2. Collateral Standard: Electromagnetic compatibility. Requirements and tests | IEC 601-1-2 |
| Industrial, scientific and medical (ISM) radio-frequency equipment - Radio disturbance characteristics - Limits and methods of measurement | EN 55011 |
| Electromagnetic compatibility (EMC) - Part 4: Testing and measurement techniques - Section 2: Electrostatic discharge immunity test - Basic EMC Publication | IEC 61000-4-2 |
| Electromagnetic compatibility (EMC) - Part 4: Testing and measurement techniques - Section 3: Radiated, radio frequency, electromagnetic field immunity test | IEC 61000-4-3 |
| Electromagnetic compatibility (EMC) - Part 4: Testing and measurement techniques - Section 4: Electrical fast transients/burst immunity test - Basic EMC Publication | IEC 61000-4-4 |
| Electromagnetic compatibility (EMC) - Part 4: Testing and measurement techniques - Section 5: Surge immunity test | IEC 61000-4-5 |
| Medical electrical equipment Part 1: General requirements for safety 4.Collateral standard: Programmable electrical medical systems | IEC 601-1-4 |
| Medical devices – Risk analysis | EN 1441 |
| Biological evaluation of medical devices - Part 1: Evaluation and testing | ISO 10 993-1 |
| The Medical Devices Directive 93/42/EEC | MDD 93/42/EEC |
| Medical electrical equipment Part 2: Particular requirements for the safety of ultrasonic therapy equipment | IEC 601-2-5 |
| Medical electrical equipment - Part 2: Particular requirements for the safety of nerve and muscle stimulators | IEC 601-2-10 |
| Medical electrical equipment Part 2: Particular requirements for the safety of diagnostic and therapeutic laser equipment | IEC 601-2-22 |
| Safety of laser products. Part 1: Equipment classification, requirements and user's guide | IEC 60 825-1 |
| Amendments to IEC 60 825-1 | A1, A2 |

7.8 INTERCONNECTION OF DEVICES

BTL-5000 Puls can be interconnected with:
BTL-5000 Combi can be interconnected with:
BTL-5000 Sono can be interconnected with:

BTL vac, BTL-5000 Sono, BTL-12, BTL-07p, BTL-4000 Sono
BTL vac, BTL-12
BTL-5000 Puls, BTL-4000 Puls

7.9 MANUFACTURER

This product is manufactured in accordance with the EU Medical Devices Directive by:

BTL Industries Ltd.

Suite 401 Albany House

324-326 Regents Street

London, W1B 3BL United Kingdom

E-mail: sales@btlnet.com

<http://www.btlnet.com>

For service, please contact service department at service@btlnet.com.

© All rights reserved. No part of this manual may be reproduced, saved in a research centre or transferred by any means incl. electronic, mechanic, photographic or other records without previous approval from BTL Industries Limited

BTL Industries Limited operates a policy of continuous development. Therefore, it reserves the right to make changes and improvements to the Product described in this manual without prior notice.

The contents of this document is provided "as is". Except as required by applicable law, no warranties of any kind, either expressed or implied, are made in relation to the accuracy, reliability or contents of this document. BTL Industries Limited reserves the right to revise this document or withdraw it at any time without prior notice.

8 UNITS CONFIGURATIONS

8.1 TABLE OF CONFIGURATIONS OF THE COMBINED DEVICES BTL 5000 COMBI

| Type: | 5800SL | 5810S | 5810S2 | 5810SL | 5810L | 5810L2 | 5820S | 5825S |
|---|----------------|----------------|----------------|----------------|----------------|----------------|----------------|----------------|
| Number of therapies | 2 | 2 | 3 | 3 | 2 | 3 | 3 | 3 |
| Electrotherapy | | 1 | 1 | 1 | 1 | 1 | 2 | 2 |
| Ultrasound therapy | 1 | 1 | 2 | 1 | | | 1 | 1 |
| Laser therapy | 1 | | | 1 | 1 | 2 | | |
| Patient cardfile (positions) | min. 150 | min. 150 | min. 150 | min. 150 | min. 150 | min. 150 | min. 150 | min. 150 |
| User programs | min. 150 | min. 150 | min. 150 | min. 150 | min. 150 | min. 150 | min. 150 | min. 150 |
| User sequences | min. 50 | min. 50 | min. 50 | min. 50 | min. 50 | min. 50 | min. 50 | min. 50 |
| Step of setting of values | standard | standard | standard | standard | standard | standard | standard | standard |
| Encyclopaedia | x | x | x | x | x | x | x | x |
| Preset diagnoses | | | | | | | | |
| Preset programs | | | | | | | | |
| Preset sequences | | | | | | | | |
| Programs | | | | | | | | |
| Interconnection with PC | optional | optional | optional | optional | optional | optional | optional | optional |
| Print | optional | optional | optional | optional | optional | optional | optional | optional |
| Language versions | x | x | x | x | x | x | x | x |
| Sound schemes | x | x | x | x | x | x | x | x |
| Display, diagonal | b/w 14.6 cm | b/w 14.6 cm | b/w 14.6 cm | b/w 14.6 cm | b/w 14.6 cm | b/w 14.6 cm | b/w 14.6 cm | b/w 14.6 cm |
| Screen saver | x | x | x | x | x | x | x | x |
| Colour schemes | | | | | | | | |
| Recent performed therapies | 20 | 20 | 20 | 20 | 20 | 20 | 20 | 20 |
| Electro parameters: | | | | | | | | |
| Channel mode | | CC / CV | CC / CV | CC / CV | CC / CV | CC / CV | CC / CV | CC / CV |
| Galvanic, Iontophoresis | | x | x | x | x | x | x | x |
| Träbert, Farad, Neofarad | | x | x | x | x | x | x | x |
| Diadynamics | | x | x | x | x | x | x | x |
| TENS | | x | x | x | x | x | x | x |
| Rectangular pulses | | x | x | x | x | x | x | x |
| Triangular pulses | | x | x | x | x | x | x | x |
| Exponential pulses | | x | x | x | x | x | x | x |
| Combined pulses | | x | x | x | x | x | x | x |
| Interrupted pulses | | | | | | | | x |
| Pulse modulation: | | x | x | x | x | x | x | x |
| random frequency sweep | | x | x | x | x | x | x | x |
| burst, surges | | x | x | x | x | x | x | x |
| Stimulation pulses | | x | x | x | x | x | x | x |
| Russian stimulation | | x | x | x | x | x | x | x |
| 2-pole interference | | x | x | x | x | x | x | x |
| 4-pole interference | | | | | | | x | x |
| Isoplanar field (interference) | | | | | | | | x |
| Vector field (interference) | | | | | | | | x |
| Electrodiagnostics: | | | | | | | | x |
| I/t curve (memory position) | | | | | | | | min. 50 |
| HVT | | optional | optional | | optional | | optional | optional |
| H – waves | | | | | | | | x |
| Spastic currents | | | | | | | | |
| Microcurrents | | | | | | | | x |
| Leduc's current | | | | | | | | x |
| Mid-frequency surges | | | | | | | | |
| Ultrasound parameters: | | | | | | | | |
| Head of 4 cm ² , 1 and 3 MHz | x | x | x | x | | | x | x |
| Head of 1 cm ² , 1 and 3 MHz | optional | optional | optional | optional | | | optional | optional |
| Detection of contact | continuous | continuous | continuous | continuous | | | continuous | continuous |
| Continuous operation mode | x | x | x | x | | | x | x |
| Pulse operation mode | x | x | x | x | | | x | x |
| Duty factor | x | x | x | x | | | x | x |
| Laser parameters: | | | | | | | | |
| Max. laser output, 685 nm | 50 mW | | | 50 mW | 50 mW | 50 mW | | |
| Max. laser output, 830 nm | 400 mW | | | 400 mW | 400 mW | 400 mW | | |
| Continuous operation mode | x | | | x | x | x | | |
| Pulse operation mode | x | | | x | x | x | | |
| Duty factor | x | | | x | x | x | | |
| Nogier frequencies | x | | | x | x | x | | |
| EAV frequencies | x | | | x | x | x | | |

Devices of types 5815 and 5821 have similar properties as 5810, but have some additional types of currents.

| Type: | 5820SL | 5825SL | 5820L | 5825L | 5830L | 5835L | 5840S | 5840SL | 5840L | 5860L |
|---|----------------|----------------|----------------|----------------|----------------|----------------|----------------|----------------|----------------|----------------|
| Number of therapies | 4 | 4 | 3 | 3 | 4 | 4 | 5 | 6 | 5 | 7 |
| Electrotherapy | 2 | 2 | 2 | 2 | 3 | 3 | 4 | 4 | 4 | 6 |
| Ultrasound therapy | 1 | 1 | | | | | 1 | 1 | | |
| Laser therapy | 1 | 1 | 1 | 1 | 1 | 1 | | 1 | 1 | 1 |
| Patient cardfile (positions) | min. 150 | min. 150 | min. 150 | min. 150 | min. 150 | min. 150 | min. 150 | min. 150 | min. 150 | min. 150 |
| User programs | min. 150 | min. 150 | min. 150 | min. 150 | min. 150 | min. 150 | min. 150 | min. 150 | min. 150 | min. 150 |
| User sequences | min. 50 | min. 50 | min. 50 | min. 50 | min. 50 | min. 50 | min. 50 | min. 50 | min. 50 | min. 50 |
| Step of setting of values | standard | standard | standard | standard | standard | standard | standard | standard | standard | standard |
| Encyclopaedia | x | x | x | x | x | x | x | x | x | x |
| Preset diagnoses | | | | | | | | | | |
| Preset programs | | | | | | | | | | |
| Preset sequences | | | | | | | | | | |
| Programs | | | | | | | | | | |
| Interconnection with PC | optional | optional | optional | optional | optional | optional | optional | optional | optional | optional |
| Print | optional | optional | optional | optional | optional | optional | optional | optional | optional | optional |
| Language versions | x | x | x | x | x | x | x | x | x | x |
| Sound schemes | x | x | x | x | x | x | x | x | x | x |
| Display, diagonal | b/w 14.6 cm | b/w 14.6 cm | b/w 14.6 cm | b/w 14.6 cm | b/w 14.6 cm | b/w 14.6 cm | b/w 14.6 cm | b/w 14.6 cm | b/w 14.6 cm | b/w 14.6 cm |
| Screen saver | x | x | x | x | x | x | x | x | x | x |
| Colour schemes | | | | | | | | | | |
| Recent performed therapies | 20 | 20 | 20 | 20 | 20 | 20 | 20 | 20 | 20 | 20 |
| Electro parameters: | | | | | | | | | | |
| Channel mode | CC / CV | CC / CV | CC / CV | CC / CV | CC / CV | CC / CV | CC / CV | CC / CV | CC / CV | CC / CV |
| Galvanic, Iontophoresis | x | x | x | x | x | x | x | x | x | x |
| Träbert, Farad, Neofarad | x | x | x | x | x | x | x | x | x | x |
| Diadynamics | x | x | x | x | x | x | x | x | x | x |
| TENS | x | x | x | x | x | x | x | x | x | x |
| Rectangular pulses | x | x | x | x | x | x | x | x | x | x |
| Triangular pulses | x | x | x | x | x | x | x | x | x | x |
| Exponential pulses | x | x | x | x | x | x | x | x | x | x |
| Combined pulses | x | x | x | x | x | x | x | x | x | x |
| Interrupted pulses | | x | | x | | x | x | x | x | x |
| Pulse modulation: | x | x | x | x | x | x | x | x | x | x |
| random frequency sweep | x | x | x | x | x | x | x | x | x | x |
| burst, surges | x | x | x | x | x | x | x | x | x | x |
| Stimulation pulses | x | x | x | x | x | x | x | x | x | x |
| Russian stimulation | x | x | x | x | x | x | x | x | x | x |
| 2-pole interference | x | x | x | x | x | x | x | x | x | x |
| 4-pole interference | x | x | x | x | x | x | x | x | x | x |
| Isoplanar field (interference) | | x | | x | | x | x | x | x | x |
| Vector field (interference) | | x | | x | | x | x | x | x | x |
| Electrodiagnostics: | | x | | x | | x | x | x | x | x |
| I/t curve (memory position) | | min. 50 | | min. 50 | | min. 50 | min. 50 | min. 50 | min. 50 | min. 50 |
| HVT | | | | | | | optional | | | |
| H – waves | | x | | x | | x | | x | x | x |
| Spastic currents | | | | | | | x | x | x | x |
| Microcurrents | | x | | x | | x | x | x | x | x |
| Leduc's current | | x | | x | | x | x | x | x | x |
| Mid-frequency surges | | | | | | | x | x | x | x |
| Ultrasound parameters: | | | | | | | | | | |
| Head of 4 cm ² , 1 and 3 MHz | x | x | | | | | x | x | | |
| Head of 1 cm ² , 1 and 3 MHz | optional | optional | | | | | optional | optional | | |
| Detection of contact | continuous | continuous | | | | | continuous | continuous | | |
| Continuous operation mode | x | x | | | | | x | x | | |
| Pulse operation mode | x | x | | | | | x | x | | |
| Duty factor | x | x | | | | | x | x | | |
| Laser parameters: | | | | | | | | | | |
| Max. laser output, 685 nm | 50 mW | 50 mW | 50 mW | 50 mW | 50 mW | 50 mW | | 50 mW | 50 mW | 50 mW |
| Max. laser output, 830 nm | 400 mW | 400 mW | 400 mW | 400 mW | 400 mW | 400 mW | | 400 mW | 400 mW | 400 mW |
| Continuous operation mode | x | x | x | x | x | x | | x | x | x |
| Pulse operation mode | x | x | x | x | x | x | | x | x | x |
| Duty factor | x | x | x | x | x | x | | x | x | x |
| Nogier frequencies | x | x | x | x | x | x | | x | x | x |
| EAV frequencies | x | x | x | x | x | x | | x | x | x |

| Type: | 5800SLC | 5810SC | 5810S2C | 5810SLC | 5810LC | 5810L2C | 5820SC | 5825SC |
|---|--------------|--------------|--------------|--------------|--------------|--------------|--------------|--------------|
| Number of therapies | 2 | 2 | 3 | 3 | 2 | 3 | 3 | 3 |
| Electrotherapy | | 1 | 1 | 1 | 1 | 1 | 2 | 2 |
| Ultrasound therapy | 1 | 1 | 2 | 1 | | | 1 | 1 |
| Laser therapy | 1 | | | 1 | 1 | 2 | | |
| Patient cardfile (positions) | min. 500 | min. 500 | min. 500 | min. 500 | min. 500 | min. 500 | min. 500 | min. 500 |
| User programs | min. 500 | min. 500 | min. 500 | min. 500 | min. 500 | min. 500 | min. 500 | min. 500 |
| User sequences | min. 150 | min. 150 | min. 150 | min. 150 | min. 150 | min. 150 | min. 150 | min. 150 |
| Step of setting of values | fine | fine | fine | fine | fine | fine | fine | fine |
| Encyclopaedia | x | x | x | x | x | x | x | x |
| Preset diagnoses | | | | | | | | |
| Preset programs | | | | | | | | |
| Preset sequences | | | | | | | | |
| Programs | | | | | | | | |
| Interconnection with PC | optional | optional | optional | optional | optional | optional | optional | optional |
| Print | optional | optional | optional | optional | optional | optional | optional | optional |
| Language versions | x | x | x | x | x | x | x | x |
| Sound schemes | x | x | x | x | x | x | x | x |
| Display, diagonal | colour 19 cm | colour 19 cm | colour 19 cm | colour 19 cm | colour 19 cm | colour 19 cm | colour 19 cm | colour 19 cm |
| Screen saver | x | x | x | x | x | x | x | x |
| Colour schemes | x | x | x | x | x | x | x | x |
| Recent performed therapies | 20 | 20 | 20 | 20 | 20 | 20 | 20 | 20 |
| Electro parameters: | | | | | | | | |
| Channel mode | | CC / CV | CC / CV | CC / CV | CC / CV | CC / CV | CC / CV | CC / CV |
| Galvanic, Iontophoresis | | x | x | x | x | x | x | x |
| Träbert, Farad, Neofarad | | x | x | x | x | x | x | x |
| Diadynamics | | x | x | x | x | x | x | x |
| TENS | | x | x | x | x | x | x | x |
| Rectangular pulses | | x | x | x | x | x | x | x |
| Triangular pulses | | x | x | x | x | x | x | x |
| Exponential pulses | | x | x | x | x | x | x | x |
| Combined pulses | | x | x | x | x | x | x | x |
| Interrupted pulses | | | | | | | | x |
| Pulse modulation: | | x | x | x | x | x | x | x |
| random frequency sweep | | x | x | x | x | x | x | x |
| burst, surges | | x | x | x | x | x | x | x |
| Stimulation pulses | | x | x | x | x | x | x | x |
| Russian stimulation | | x | x | x | x | x | x | x |
| 2-pole interference | | x | x | x | x | x | x | x |
| 4-pole interference | | | | | | | x | x |
| Isoplanar field (interference) | | | | | | | | x |
| Vector field (interference) | | | | | | | | x |
| Electrodiagnostics: | | | | | | | | x |
| I/t curve (memory position) | | | | | | | | min. 50 |
| HVT | | optional | optional | | optional | | optional | optional |
| H – waves | | | | | | | | x |
| Spastic currents | | | | | | | | |
| Microcurrents | | | | | | | | x |
| Leduc's current | | | | | | | | x |
| Mid-frequency surges | | | | | | | | |
| Ultrasound parameters: | | | | | | | | |
| Head of 4 cm ² , 1 and 3 MHz | x | x | x | x | | | x | x |
| Head of 1 cm ² , 1 and 3 MHz | optional | optional | optional | optional | | | optional | optional |
| Detection of contact | continuous | continuous | continuous | continuous | | | continuous | continuous |
| Continuous operation mode | x | x | x | x | | | x | x |
| Pulse operation mode | x | x | x | x | | | x | x |
| Duty factor | x | x | x | x | | | x | x |
| Laser parameters: | | | | | | | | |
| Max. laser output, 685 nm | 50 mW | | | 50 mW | 50 mW | 50 mW | | |
| Max. laser output, 830 nm | 400 mW | | | 400 mW | 400 mW | 400 mW | | |
| Continuous operation mode | x | | | x | x | x | | |
| Pulse operation mode | x | | | x | x | x | | |
| Duty factor | x | | | x | x | x | | |
| Nogier frequencies | x | | | x | x | x | | |
| EAV frequencies | x | | | x | x | x | | |

Devices of types 5815 and 5821 have similar properties as 5810, but have some additional types of currents.

| Type: | 5820SLC | 5825SLC | 5820LC | 5825LC | 5830LC | 5835LC | 5840SC | 5840SLC | 5840LC | 5860LC |
|---|--------------|--------------|--------------|--------------|--------------|--------------|--------------|--------------|--------------|--------------|
| Number of therapies | 4 | 4 | 3 | 3 | 4 | 4 | 5 | 6 | 5 | 7 |
| Electrotherapy | 2 | 2 | 2 | 2 | 3 | 3 | 4 | 4 | 4 | 6 |
| Ultrasound therapy | 1 | 1 | | | | | 1 | 1 | | |
| Laser therapy | 1 | 1 | 1 | 1 | 1 | 1 | | 1 | 1 | 1 |
| Patient cardfile (positions) | min. 500 | min. 500 | min. 500 | min. 500 | min. 500 | min. 500 | min. 500 | min. 500 | min. 500 | min. 500 |
| User programs | min. 500 | min. 500 | min. 500 | min. 500 | min. 500 | min. 500 | min. 500 | min. 500 | min. 500 | min. 500 |
| User sequences | min. 150 | min. 150 | min. 150 | min. 150 | min. 150 | min. 150 | min. 150 | min. 150 | min. 150 | min. 150 |
| Step of setting of values | fine | fine | fine | fine | fine | fine | fine | fine | fine | fine |
| Encyclopaedia | x | x | x | x | x | x | x | x | x | x |
| Preset diagnoses | | | | | | | | | | |
| Preset programs | | | | | | | | | | |
| Preset sequences | | | | | | | | | | |
| Programs | | | | | | | | | | |
| Interconnection with PC | optional | optional | optional | optional | optional | optional | optional | optional | optional | optional |
| Print | optional | optional | optional | optional | optional | optional | optional | optional | optional | optional |
| Language versions | x | x | x | x | x | x | x | x | x | x |
| Sound schemes | x | x | x | x | x | x | x | x | x | x |
| Display, diagonal | colour 19 cm | colour 19 cm | colour 19 cm | colour 19 cm | colour 19 cm | colour 19 cm | colour 19 cm | colour 19 cm | colour 19 cm | colour 19 cm |
| Screen saver | x | x | x | x | x | x | x | x | x | x |
| Colour schemes | x | x | x | x | x | x | x | x | x | x |
| Recent performed therapies | 20 | 20 | 20 | 20 | 20 | 20 | 20 | 20 | 20 | 20 |
| Electro parameters: | | | | | | | | | | |
| Channel mode | CC / CV | CC / CV | CC / CV | CC / CV | CC / CV | CC / CV | CC / CV | CC / CV | CC / CV | CC / CV |
| Galvanic, Iontophoresis | x | x | x | x | x | x | x | x | x | x |
| Träbert, Farad, Neofarad | x | x | x | x | x | x | x | x | x | x |
| Diadynamics | x | x | x | x | x | x | x | x | x | x |
| TENS | x | x | x | x | x | x | x | x | x | x |
| Rectangular pulses | x | x | x | x | x | x | x | x | x | x |
| Triangular pulses | x | x | x | x | x | x | x | x | x | x |
| Exponential pulses | x | x | x | x | x | x | x | x | x | x |
| Combined pulses | x | x | x | x | x | x | x | x | x | x |
| Interrupted pulses | | x | | x | | x | x | x | x | x |
| Pulse modulation: | x | x | x | x | x | x | x | x | x | x |
| random frequency sweep | x | x | x | x | x | x | x | x | x | x |
| burst, surges | x | x | x | x | x | x | x | x | x | x |
| Stimulation pulses | x | x | x | x | x | x | x | x | x | x |
| Russian stimulation | x | x | x | x | x | x | x | x | x | x |
| 2-pole interference | x | x | x | x | x | x | x | x | x | x |
| 4-pole interference | x | x | x | x | x | x | x | x | x | x |
| Isoplanar field (interference) | | x | | x | | x | x | x | x | x |
| Vector field (interference) | | x | | x | | x | x | x | x | x |
| Electrodiagnostics: | | x | | x | | x | x | x | x | x |
| I/t curve (memory position) | | min. 50 | | min. 50 | | min. 50 | min. 50 | min. 50 | min. 50 | min. 50 |
| HVT | | | | | | | optional | | | |
| H – waves | | x | | x | | x | | x | x | x |
| Spastic currents | | | | | | | x | x | x | x |
| Microcurrents | | x | | x | | x | x | x | x | x |
| Leduc's current | | x | | x | | x | x | x | x | x |
| Mid-frequency surges | | | | | | | x | x | x | x |
| Ultrasound parameters: | | | | | | | | | | |
| Head of 4 cm ² , 1 and 3 MHz | x | x | | | | | x | x | | |
| Head of 1 cm ² , 1 and 3 MHz | optional | optional | | | | | optional | optional | | |
| Detection of contact | continuous | continuous | | | | | continuous | continuous | | |
| Continuous operation mode | x | x | | | | | x | x | | |
| Pulse operation mode | x | x | | | | | x | x | | |
| Duty factor | x | x | | | | | x | x | | |
| Laser parameters: | | | | | | | | | | |
| Max. laser output, 685 nm | 50 mW | 50 mW | 50 mW | 50 mW | 50 mW | 50 mW | | 50 mW | 50 mW | 50 mW |
| Max. laser output, 830 nm | 400 mW | 400 mW | 400 mW | 400 mW | 400 mW | 400 mW | | 400 mW | 400 mW | 400 mW |
| Continuous operation mode | x | x | x | x | x | x | | x | x | x |
| Pulse operation mode | x | x | x | x | x | x | | x | x | x |
| Duty factor | x | x | x | x | x | x | | x | x | x |
| Nogier frequencies | x | x | x | x | x | x | | x | x | x |
| EAV frequencies | x | x | x | x | x | x | | x | x | x |

8.2 TABLE OF CONFIGURATIONS OF THE ELECTROTHERAPY DEVICES BTL-5000 PULS

| Type: | 5610 | 5620 | 5625 | 5630 | 5635 | 5640 | 5660 | 5620C | 5625C | 5630C | 5635C | 5640C | 5660C |
|---------------------------------|----------------|----------------|----------------|----------------|----------------|----------------|----------------|-----------------|-----------------|-----------------|-----------------|-----------------|-----------------|
| Number of electrotherapies | 1 | 2 | 2 | 3 | 3 | 4 | 6 | 2 | 2 | 3 | 3 | 4 | 6 |
| Patient cardfile (positions) | min. 150 | min. 150 | min. 150 | min. 150 | min. 150 | min. 150 | min. 150 | min. 500 | min. 500 | min. 500 | min. 500 | min. 500 | min. 500 |
| User programs / diagnoses | min. 150 | min. 150 | min. 150 | min. 150 | min. 150 | min. 150 | min. 150 | min. 500 | min. 500 | min. 500 | min. 500 | min. 500 | min. 500 |
| User sequences | min. 50 | min. 50 | min. 50 | min. 50 | min. 50 | min. 50 | min. 50 | min. 150 | min. 150 | min. 150 | min. 150 | min. 150 | min. 150 |
| Step of setting of values | standard | standard | standard | standard | standard | standard | standard | fine | fine | fine | fine | fine | fine |
| Encyclopaedia | x | x | x | x | x | x | x | x | x | x | x | x | x |
| Preset diagnoses | 49 | 58 | 58 | 58 | 58 | 59 | 59 | 58 | 58 | 58 | 58 | 59 | 59 |
| Preset programs | 55 | 75 | 89 | 75 | 89 | 90 | 90 | 75 | 89 | 75 | 89 | 90 | 90 |
| Preset sequences | 12 | 12 | 12 | 12 | 12 | 12 | 12 | 12 | 12 | 12 | 12 | 12 | 12 |
| Programs | 2903 | 3957 | 4577 | 3957 | 4577 | 4579 | 4579 | 3957 | 4577 | 3957 | 4577 | 4579 | 4579 |
| Interconnection with PC | optional | optional | optional | optional | optional | optional | optional | optional | optional | optional | optional | optional | optional |
| Print | optional | optional | optional | optional | optional | optional | optional | optional | optional | optional | optional | optional | optional |
| Interconnection with ultrasound | x | x | x | x | x | x | x | x | x | x | x | x | x |
| Language versions | x | x | x | x | x | x | x | x | x | x | x | x | x |
| Sound schemes | x | x | x | x | x | x | x | x | x | x | x | x | x |
| Display, diagonal | b/w 14.6 cm | b/w 14.6 cm | b/w 14.6 cm | b/w 14.6 cm | b/w 14.6 cm | b/w 14.6 cm | b/w 14.6 cm | colour 19 cm | colour 19 cm | colour 19 cm | colour 19 cm | colour 19 cm | colour 19 cm |
| Screen saver | x | x | x | x | x | x | x | x | x | x | x | x | x |
| Colour schemes | | | | | | | | x | x | x | x | x | x |
| Recent performed therapies | 20 | 20 | 20 | 20 | 20 | 20 | 20 | 20 | 20 | 20 | 20 | 20 | 20 |
| Electro parameters: | | | | | | | | | | | | | |
| Channel mode | CC / CV | CC / CV | CC / CV | CC / CV | CC / CV | CC / CV | CC / CV | CC / CV | CC / CV | CC / CV | CC / CV | CC / CV | CC / CV |
| Galvanic, Iontophoresis | x | x | x | x | x | x | x | x | x | x | x | x | x |
| Träbert, Farad, Neofarad | x | x | x | x | x | x | x | x | x | x | x | x | x |
| Diadynamics | x | x | x | x | x | x | x | x | x | x | x | x | x |
| TENS | x | x | x | x | x | x | x | x | x | x | x | x | x |
| Rectangular pulses | x | x | x | x | x | x | x | x | x | x | x | x | x |
| Triangular pulses | | x | x | x | x | x | x | x | x | x | x | x | x |
| Exponential pulses | | x | x | x | x | x | x | x | x | x | x | x | x |
| Combined pulses | | x | x | x | x | x | x | x | x | x | x | x | x |
| Interrupted pulses | | | x | | x | x | x | | x | | x | x | x |
| Pulse modulation: | | | | | | | | | | | | | |
| random frequency sweep | x | x | x | x | x | x | x | x | x | x | x | x | x |
| burst, surges | x | x | x | x | x | x | x | x | x | x | x | x | x |
| Stimulation pulses | x | x | x | x | x | x | x | x | x | x | x | x | x |
| Russian stimulation | x | x | x | x | x | x | x | x | x | x | x | x | x |
| 2-pole interference | x | x | x | x | x | x | x | x | x | x | x | x | x |
| 4-pole interference | | x | x | x | x | x | x | x | x | x | x | x | x |
| Isoplanar field (interference) | | | x | | x | x | x | | x | | x | x | x |
| Vector field (interference) | | | x | | x | x | x | | x | | x | x | x |
| Electrodiagnostics: | | | | | | | | | | | | | |
| I/t curve (memory position) | | | min. 50 | | min. 50 | min. 50 | min. 50 | | min. 50 | | min. 50 | min. 50 | min. 50 |
| HVT | optional | optional | optional | optional | optional | optional | optional | optional | optional | optional | optional | optional | optional |
| H – waves | | | x | | x | x | x | | x | | x | x | x |
| Spastic currents | | | | | x | x | x | | | | | x | x |
| Microcurrents | | | x | | x | x | x | | x | | x | x | x |
| Leduc's current | | | x | | x | x | x | | x | | x | x | x |
| Mid-frequency surges | | | | | x | x | x | | | | | x | x |

Devices of types 5615 and 5621 have similar properties as 5610, but have some additional types of currents.

8.3 TABLE OF CONFIGURATIONS OF THE ULTRASOUND THERAPY DEVICES BTL-5000 SONO

| Type: | 5710 | 5720 | 5710C | 5720C |
|---|----------------|----------------|-----------------|-----------------|
| Number of ultrasound therapies | 1 | 2 | 1 | 2 |
| Patient cardfile (positions) | min. 150 | min. 150 | min. 500 | min. 500 |
| User programs | min. 150 | min. 150 | min. 500 | min. 500 |
| User sequences | min. 50 | min. 50 | min. 150 | min. 150 |
| Step of setting of values | standard | standard | fine | fine |
| Encyclopaedia | x | x | x | x |
| Preset diagnoses | 66 | 66 | 66 | 66 |
| Preset programs | 66 | 66 | 66 | 66 |
| Interconnection with BTL-5000 Puls | x | x | x | x |
| Interconnection with PC | optional | optional | optional | optional |
| Print | optional | optional | optional | optional |
| Language versions | x | x | x | x |
| Sound schemes | x | x | x | x |
| Display, diagonal | b/w 14.6 cm | b/w 14.6 cm | colour 19 cm | colour 19 cm |
| Screen saver | x | x | x | x |
| Colour schemes | | | x | x |
| Recent performed therapies | 20 | 20 | 20 | 20 |
| Ultrasound parameters: | | | | |
| Head of 4 cm ² , 1 and 3 MHz | x | x | x | x |
| Head of 1 cm ² , 1 and 3 MHz | optional | optional | optional | optional |
| Detection of contact | continuous | continuous | continuous | continuous |
| Continuous operation mode | x | x | x | x |
| Pulse operation mode | x | x | x | x |
| Duty factor | x | x | x | x |

8.4 TABLE OF CONFIGURATIONS OF THE LASER THERAPY DEVICES BTL-5000 LASER

| Type: | 5110 | 5120 | 5110C | 5120C |
|------------------------------|----------------|----------------|-----------------|-----------------|
| Number of laser therapies | 1 | 2 | 1 | 2 |
| Patient cardfile (positions) | min. 150 | min. 150 | min. 500 | min. 500 |
| User programs | min. 150 | min. 150 | min. 500 | min. 500 |
| User sequences | min. 50 | min. 50 | min. 150 | min. 150 |
| Step of setting of values | standard | standard | fine | fine |
| Encyclopaedia | x | x | x | x |
| Preset diagnoses | | | | |
| Preset programs | | | | |
| Interconnection with PC | optional | optional | optional | optional |
| Print | optional | optional | optional | optional |
| Language versions | x | x | x | x |
| Sound schemes | x | x | x | x |
| Display, diagonal | b/w 14.6 cm | b/w 14.6 cm | colour 19 cm | colour 19 cm |
| Screen saver | x | x | x | x |
| Colour schemes | | | x | x |
| Recent performed therapies | 20 | 20 | 20 | 20 |
| Laser parameters: | | | | |
| Max. laser output, 685 nm | 50 mW | 50 mW | 50 mW | 50 mW |
| Max. laser output, 830 nm | 400 mW | 400 mW | 400 mW | 400 mW |
| Continuous operation mode | x | x | x | x |
| Pulse operation mode | x | x | x | x |
| Duty factor | x | x | x | x |
| Nogier frequencies | x | x | x | x |
| EAV frequencies | x | x | x | x |

